



**The Pinouts Book** was created for designers and engineers as a quick reference for remembering the functions of all the different pinouts in your electronics projects.

The book covers a range of commonly used components, such as connectors, single board computers, dev boards, microcontroller chips, modules and more.

More technical information for each component is available by going to the "**pinouts.org/XXX**" URLs at the top of the pages. These each redirect to official datasheets or specifications.

For more info, visit **pinouts.org**

Happy building :)  
*NODE & Baptiste*

# CONTENTS

## CONNECTORS / AUDIO VIDEO

3.5MM (2 CONTACT / TS).....	008
3.5MM (3 CONTACT / TRS).....	010
3.5MM (4 CONTACT / TRRS).....	012
DISPLAYPORT.....	014
DVI-D (DUAL LINK).....	016
HDMI TYPE A.....	018
HDMI TYPE C (MINI).....	020
HDMI TYPE D (MICRO).....	022
MINI DISPLAYPORT.....	024
MINI DVI.....	026
S-VIDEO.....	028
VGA.....	030

## CONNECTORS / USB

USB TYPE MICRO-B 3.0.....	032
USB TYPE MICRO-B.....	034
USB TYPE-A 2.0.....	036
USB TYPE-A 3.0.....	038
USB TYPE-B 2.0.....	040
USB TYPE-B 3.0.....	042
USB TYPE-MINI-B 2.0.....	044
USB-C.....	046

## CONNECTORS / MISCELLANEOUS

ESATA.....	048
ETHERNET (RJ45).....	050
FIREWIRE.....	052
LIGHTNING CABLE.....	054

PHONE LINE (RJ11).....	056
PS/2.....	058
RS-232 SERIAL (DB25).....	060
RS-232 SERIAL (DB9).....	062

## MEMORY / MEMORY CARDS

COMPACT FLASH.....	066
MEMORY STICK PRO DUO.....	068
MICRO SD CARD.....	070
MULTIMEDIA CARD.....	072
SD CARD.....	074
XD PICTURE CARD.....	076

## BOARDS / ADAFRUIT

ADAFRUIT FEATHER 32U4 ADALOGGER.....	080
ADAFRUIT FEATHER 32U4 BLUEFRUIT LE.....	084
ADAFRUIT FEATHER 32U4 FONAL.....	088
ADAFRUIT FEATHER 32U4 RFM69HCW.....	092
ADAFRUIT FEATHER HUZZAH WITH ESP8266.....	096
ADAFRUIT FEATHER M0 ADALOGGER.....	100
ADAFRUIT FEATHER M0 BASIC PROTO.....	104
ADAFRUIT FEATHER M0 BLUEFRUIT LE.....	108
ADAFRUIT FEATHER M0 RFM69HCW.....	112
ADAFRUIT METRO MINI 328 5V.....	116
ADAFRUIT TRINKET 5V.....	118

## BOARDS / ARDUINO

ARDUINO DUE.....	120
ARDUINO LEONARDO.....	126
ARDUINO MEGA 2560 REV3.....	128

ARDUINO MICRO.....	134
ARDUINO MKR 1000 WIFI.....	136
ARDUINO MKR 1010 WIFI.....	138
ARDUINO MKR FOX 1200.....	140
ARDUINO MKR GSM 1400.....	142
ARDUINO MKR NB 1500.....	144
ARDUINO MKR WAN 1310.....	146
ARDUINO MKR ZERO.....	148
ARDUINO NANO 33 BLE.....	150
ARDUINO NANO 33 IOT.....	152
ARDUINO NANO EVERY.....	154
ARDUINO NANO.....	156
ARDUINO UNO REV 3.....	158

#### **BOARDS / RASPBERRY PI**

RASPBERRY PI 4 MODEL B.....	162
RASPBERRY PI 3 MODEL B+.....	164
RASPBERRY PI 3 MODEL A+.....	166
RASPBERRY PI COMPUTE MODULE 3+.....	168
RASPBERRY PI COMPUTE MODULE 3+ LITE.....	172
RASPBERRY PI COMPUTE MODULE 4 (& LITE).....	176
RASPBERRY PI PICO.....	180
RASPBERRY PI ZERO.....	182
RASPBERRY PI ZERO W.....	184
RASPBERRY PI ZERO 2 W.....	186

#### **BOARDS / OTHER DEV BOARDS**

ESPRUINO PICO.....	188
ESPRUINO WIFI.....	192
IOIO-OTG V2.2.....	194

MBED LPC1768.....	196
NODEMCU.....	198
OKDO E1.....	200
PARTICLE ARGON.....	202
PARTICLE BORON.....	204
PARTICLE ELECTRON.....	206
PARTICLE PHOTON.....	210
SIFIVE HIFIVE1 REV B.....	212
SPARKFUN PRO MICRO.....	214
SPARKFUN REDBOARD.....	216
SPARKFUN THING PLUS SAMD51.....	218

#### **BOARDS / OTHER SBCS**

ASUS TINKER BOARD S.....	220
ASUS TINKER EDGE R.....	222
ASUS TINKER EDGE T.....	224
BANANA PI M2 ZERO.....	226
BANANA PI M4.....	228
BBC MICRO:BIT V1.....	230
BBC MICRO:BIT V2.....	232
BEAGLEBONE BLACK REV C.....	234
LIBRE COMPUTER ALL-H3-CC.....	236
LIBRE COMPUTER AML-S905X-CC.....	238
LIBRE COMPUTER ROC-RK3328-CC.....	242
NANOPI DUO2.....	244
NANOPI FIRE3-LTS.....	246
NANOPI M4.....	248
NANOPI NEO AIR-LTS.....	250
NANOPI NEO-LTS.....	252
ODROID-C4.....	254

ODROID-N2+.....	258
PINE ROCK 64.....	260
PINE ROCKPRO 64.....	264

PICAXE 14M2 (14 PIN).....	314
PICAXE 18M2+ (18 PIN).....	316

## **BOARDS / COMMUNICATIONS MODULES**

BC127 BLUETOOTH SMD MODULE.....	266
ESP32 S2 WROVER MODULE WI-FI MODULE.....	268
ESP32 WROOM 32D WI-FI+BT+BLE MODULE.....	270
ESP8266 SMT MODULE (ESP-12F).....	272
LS20031 5HZ (66 CHANNEL) GPS RECEIVER.....	274
RAYTAC NRF51822 BLUETOOTH LE MODULE.....	276
RAYTAC NRF52832 BLUETOOTH LE MODULE.....	278
RN-42 (V6.15) BLUETOOTH SMD MODULE.....	280
SPARKFUN COPERNICUS II DIP.....	282

## **CHIPS / MICROCONTROLLER CHIPS**

ATMEGA2560-16AU (TQFP 100 PIN).....	286
ATMEGA32-16AU (TQFP 44 PIN).....	288
ATMEGA32-16PU (PDIP 40 PIN).....	290
ATMEGA328-AU (TQFP 32 PIN).....	292
ATMEGA328-PU (SPDIP 28 PIN).....	294
ATSAMD21G18A-AU (TQFP 48 PIN).....	296
ATTINY25-20SSU (SOIC 8 PIN).....	298
ATTINY25V-20PU (PDIP 8 PIN).....	300
ATTINY45-20PU (PDIP 8 PIN).....	302
ATTINY45-20SU (SOIC 8 PIN).....	304
ATTINY45-20XU (TSSOP 8 PIN).....	306
ATTINY85-20PU (PDIP 8 PIN).....	308
ATTINY85-20SU (SOIC 8 PIN).....	310
PICAXE 08M2 (8 PIN).....	312

CONNECTORS





CONNECTORS / AUDIO & VIDEO / 3.5MM (2 CONTACT / TS)

*PINOUTS.ORG/A01*

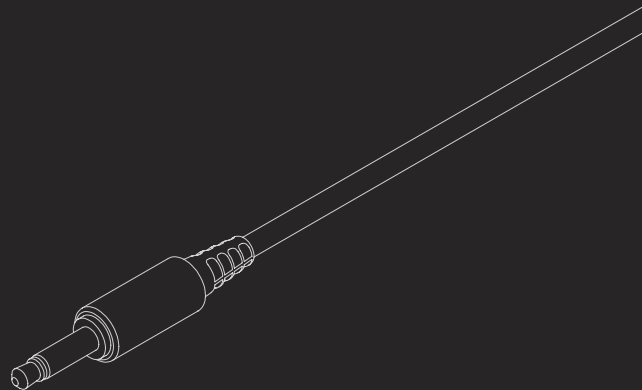
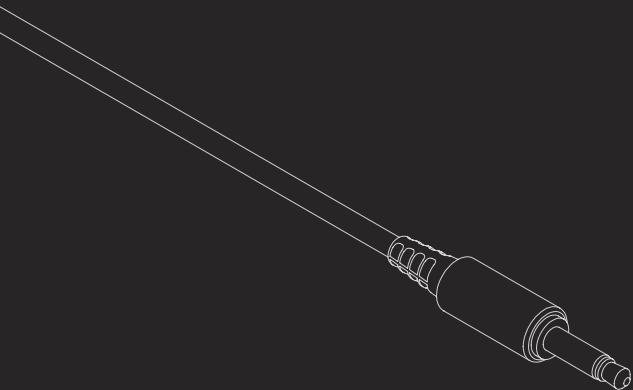

#	NAME	TYPICAL FUNCTION*
1	TIP	MONO SIGNAL (+)
2	SLEEVE	GROUND (-)

*\*May vary depending on application*

CONNECTORS / AUDIO & VIDEO / 3.5MM (3 CONTACT / TRS)

[PINOUTS.ORG/A02](http://PINOUTS.ORG/A02)

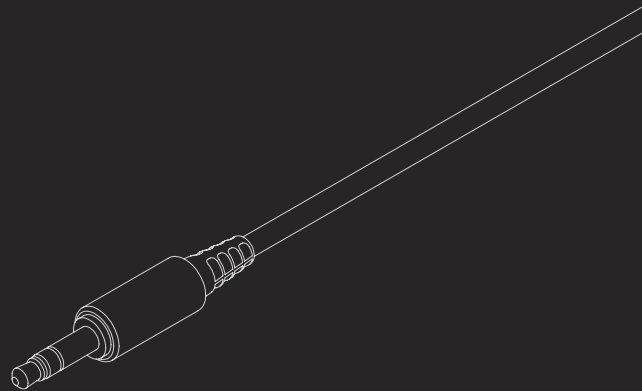
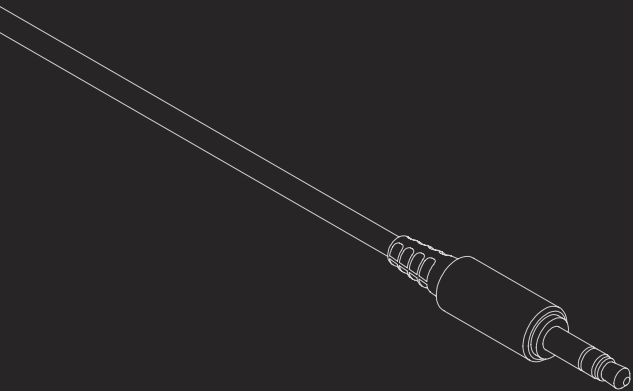

#	NAME	TYPICAL FUNCTION*
1	TIP	LEFT CHANNEL
2	RING	RIGHT CHANNEL
3	SLEEVE	GROUND

*\*May vary depending on application*

CONNECTORS / AUDIO & VIDEO / 3.5MM (4 CONTACT / TRRS)

[PINOUTS.ORG/A03](http://PINOUTS.ORG/A03)

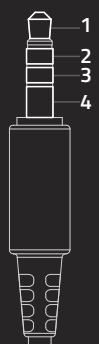
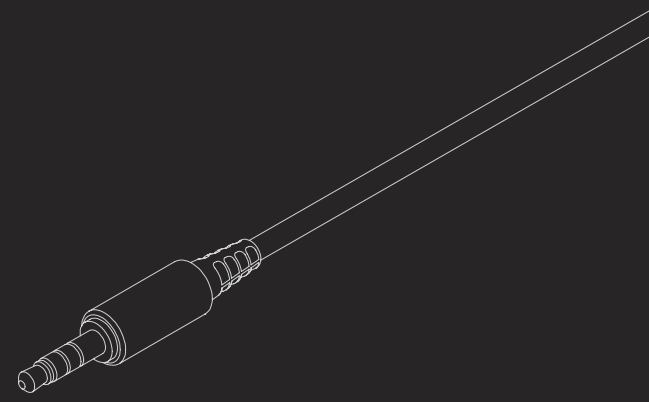
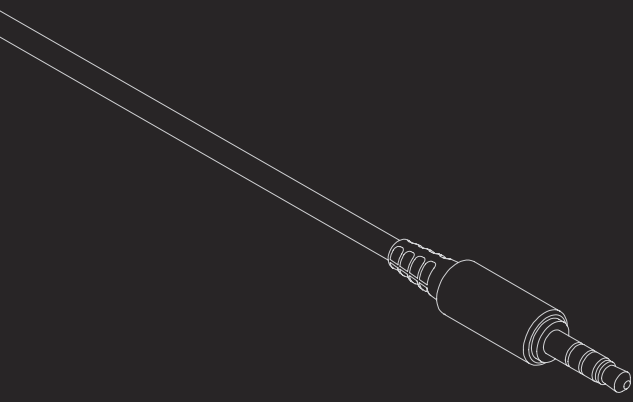

#	NAME	TYPICAL FUNCTION*
1	TIP	LEFT CHANNEL
2	RING	RIGHT CHANNEL
3	RING	GROUND
4	SLEEVE	MICROPHONE

*\*May vary depending on application*

CONNECTORS / AUDIO & VIDEO / DISPLAYPORT

*PINOUTS.ORG/A04*

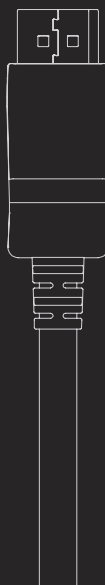
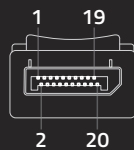



SOURCE / DOWNSTREAM SIDE		
#	NAME	NOTES
1	OUT	ML_LANE 0 (+)
2	GND	GROUND
3	OUT	ML_LANE 0 (-)
4	OUT	ML_LANE 1 (+)
5	GND	GROUND
6	OUT	ML_LANE 1 (-)
7	OUT	ML_LANE 2 (+)
8	GND	GROUND
9	OUT	ML_LANE 2 (-)
10	OUT	ML_LANE 3 (+)
11	GND	GROUND
12	OUT	ML_LANE 3 (-)
13	CONFIG*	CONFIG1
14	CONFIG*	CONFIG2
15	I/O	AUX CH (+)
16	GND	GROUND
17	I/O	AUX CH (-)
18	IN	HOT PLUG DETECT
19	RTN	RETURN
20	PWR OUT**	DP_PWR

RECEIVING / UPSTREAM SIDE		
#	NAME	NOTES
1	IN	ML_LANE 3 (-)
2	GND	GROUND
3	IN	ML_LANE 3 (+)
4	IN	ML_LANE 2 (-)
5	GND	GROUND
6	IN	ML_LANE 2 (+)
7	IN	ML_LANE 1 (-)
8	GND	GROUND
9	IN	ML_LANE 1 (+)
10	IN	ML_LANE 0 (-)
11	GND	GROUND
12	IN	ML_LANE 0 (+)
13	CONFIG*	CONFIG1
14	CONFIG*	CONFIG2
15	I/O	AUX CH (+)
16	GND	GROUND
17	I/O	AUX CH (-)
18	OUT	HOT PLUG DETECT
19	RTN	RETURN
20	PWR OUT**	DP_PWR

\* 13 & 14 must be connected to ground through a pull-down device

\*\* Must provide +3.3V ± 10% with a max current of 500mA and a min capability of 1.5 watts

CONNECTORS / AUDIO & VIDEO / DVI-D (DUAL LINK)

*PINOUTS.ORG/A05*

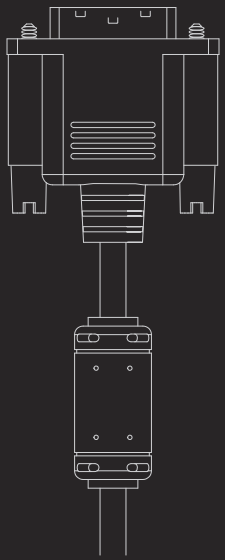
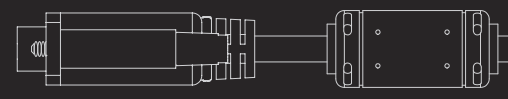
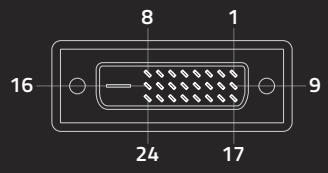
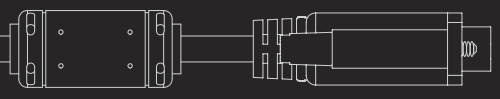
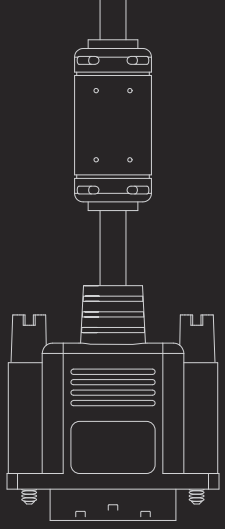

#	NAME	#	NAME
1	TMDS DATA2-	13	TMDS DATA3+
2	TMDS DATA2+	14	+5V POWER
3	TMDS DATA2/4 SHIELD	15	GROUND (FOR +5V)
4	TMDS DATA4-	16	HOT PLUG DETECT
5	TMDS DATA4+	17	TMDS DATA0-
6	DDC CLOCK	18	TMDS DATA0+
7	DDC DATA	19	TMDS DATA0/5 SHIELD
8	NO CONNECT	20	TMDS DATA5-
9	TMDS DATA1-	21	TMDS DATA5+
10	TMDS DATA1+	22	TMDS CLOCK SHIELD
11	TMDS DATA1/3 SHIELD	23	TMDS CLOCK+
12	TMDS DATA3-	24	TMDS CLOCK-

CONNECTORS / AUDIO & VIDEO / HDMI TYPE A

[PINOUTS.ORG/A06](http://PINOUTS.ORG/A06)

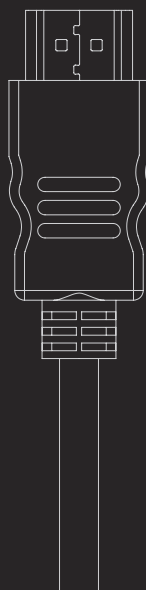
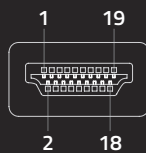
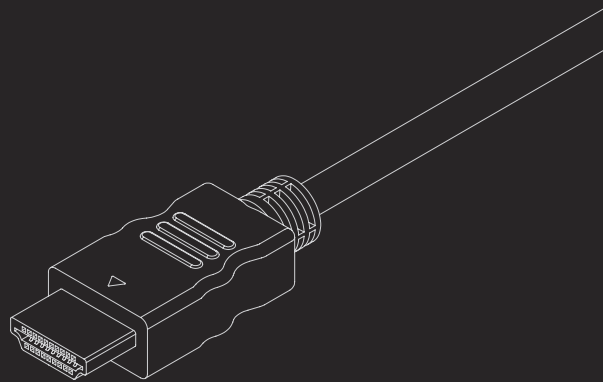
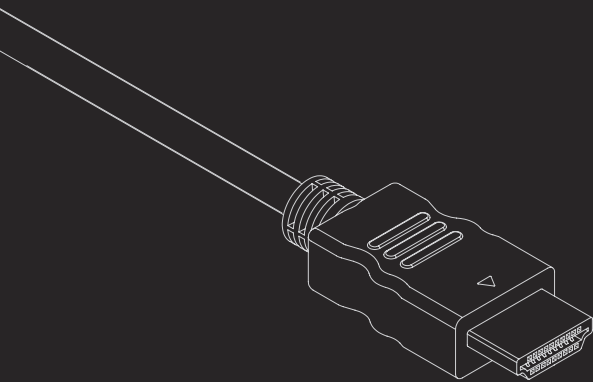

#	NAME
1	TMDS DATA2+
2	TMDS DATA2 SHIELD
3	TMDS DATA2-
4	TMDS DATA1+
5	TMDS DATA1 SHIELD
6	TMDS DATA1-
7	TMDS DATA0+
8	TMDS DATA0 SHIELD
9	TMDS DATA0-
10	TMDS CLOCK+
11	TMDS CLOCK SHIELD
12	TMDS CLOCK-
13	CEC
14	UTILITY
15	SCL
16	SDA
17	DDC/CEC GROUND
18	+5V POWER (MIN 55mA)
19	HOT PLUG DETECT

CONNECTORS / AUDIO & VIDEO / HDMI TYPE C (MINI)

*PINOUTS.ORG/A07*

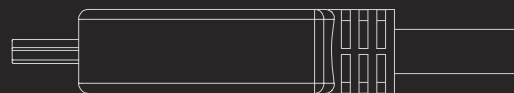
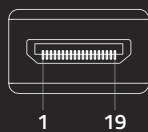
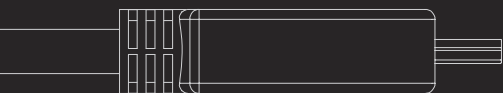
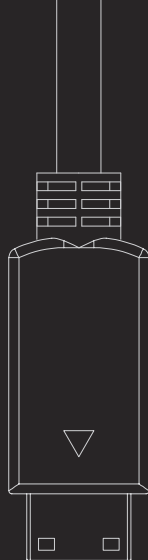

#	NAME
1	TMDS DATA2 SHIELD
2	TMDS DATA2+
3	TMDS DATA2-
4	TMDS DATA1 SHIELD
5	TMDS DATA1+
6	TMDS DATA1-
7	TMDS DATA0 SHIELD
8	TMDS DATA0+
9	TMDS DATA0-
10	TMDS CLOCK SHIELD
11	TMDS CLOCK+
12	TMDS CLOCK-
13	DDC/CEC GROUND
14	CEC
15	SCL
16	SDA
17	UTILITY
18	+5V POWER (MIN 55mA)
19	HOT PLUG DETECT

CONNECTORS / AUDIO & VIDEO / HDMI TYPE D (MICRO)

[PINOUTS.ORG/A08](http://PINOUTS.ORG/A08)

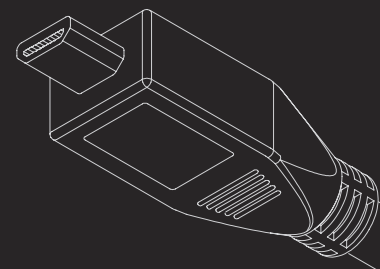
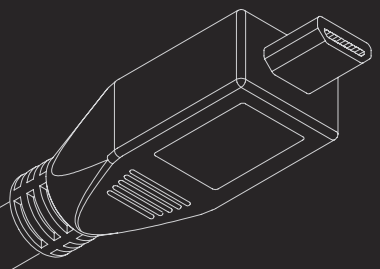
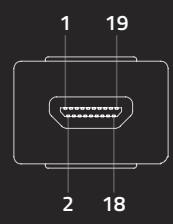
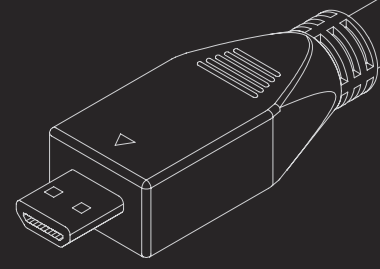
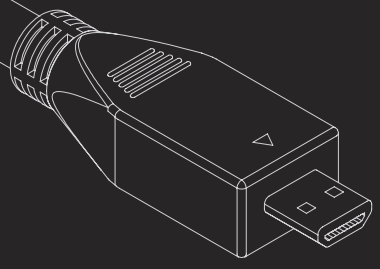



#	NAME
1	HOT PLUG DETECT
2	UTILITY
3	TMDS DATA2+
4	TMDS DATA2 SHIELD
5	TMDS DATA2-
6	TMDS DATA1+
7	TMDS DATA1 SHIELD
8	TMDS DATA1-
9	TMDS DATA0+
10	TMDS DATA0 SHIELD
11	TMDS DATA0-
12	TMDS CLOCK+
13	TMDS CLOCK SHIELD
14	TMDS CLOCK-
15	CEC
16	DDC/CEC GROUND
17	SCL
18	SDA
19	+5V POWER (MIN 55mA)

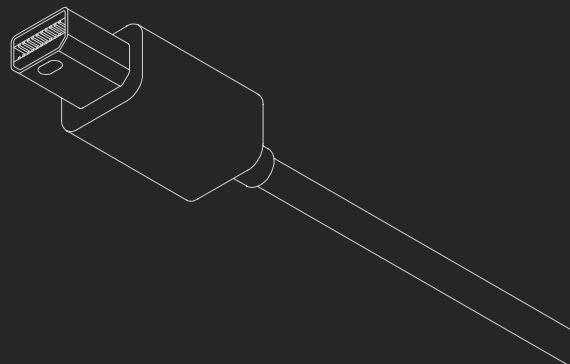
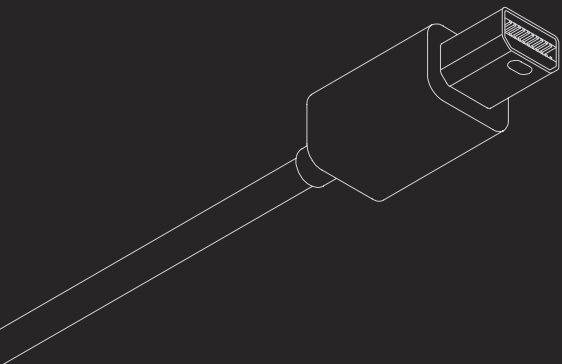
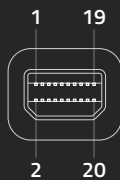
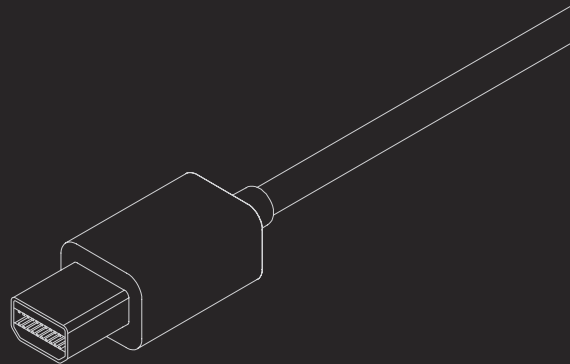
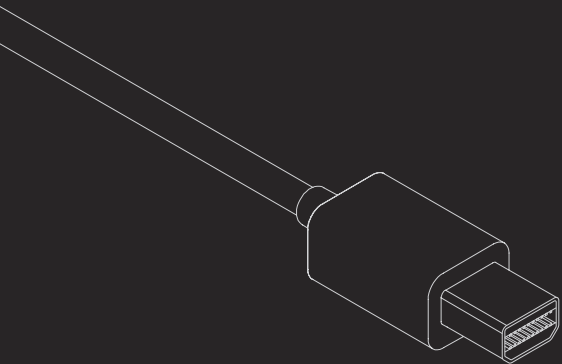

SOURCE / DOWNSTREAM SIDE		
#	NAME	NOTES
1	GND	GROUND
2	IN	HOT PLUG DETECT
3	OUT	ML_LANE 0 (+)
4	CONFIG*	CONFIG1
5	OUT	ML_LANE 0 (-)
6	CONFIG*	CONFIG2
7	GND	GROUND
8	GND	GROUND
9	OUT	ML_LANE 1 (+)
10	OUT	ML_LANE 3 (+)
11	OUT	ML_LANE1 (-)
12	OUT	ML_LANE 3 (-)
13	GND	GROUND
14	GND	GROUND
15	OUT	ML_LANE 2 (+)
16	I/O	AUX_CH (+)
17	OUT	ML_LANE 2 (-)
18	I/O	AUX_CH (-)
19	GND	GROUND
20	PWR OUT**	DP_PWR

RECEIVING / UPSTREAM SIDE		
#	NAME	NOTES
1	GND	GROUND
2	OUT	HOT PLUG DETECT
3	IN	ML_LANE 3 (-)
4	CONFIG*	CONFIG1
5	IN	ML_LANE 3 (+)
6	CONFIG*	CONFIG2
7	GND	GROUND
8	GND	GROUND
9	IN	ML_LANE 2 (-)
10	IN	ML_LANE 0 (-)
11	IN	ML_LANE 2 (+)
12	IN	ML_LANE 0 (+)
13	GND	GROUND
14	GND	GROUND
15	IN	ML_LANE 1 (-)
16	I/O	AUX_CH (+)
17	IN	ML_LANE 1 (+)
18	I/O	AUX_CH (-)
19	GND	GROUND
20	PWR OUT**	DP_PWR

\* 4 & 6 must be connected to ground through a pull-down device

\*\* Must provide +3.3V  $\pm$  10% with a max current of 500mA and a min capability of 1.5 watts

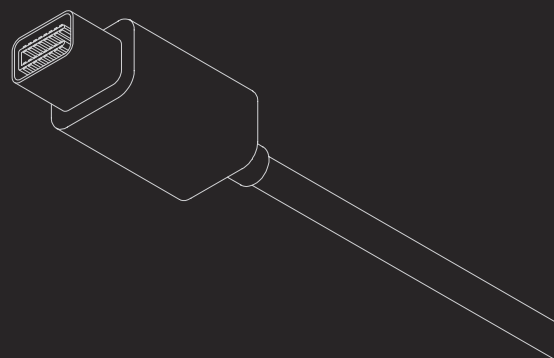
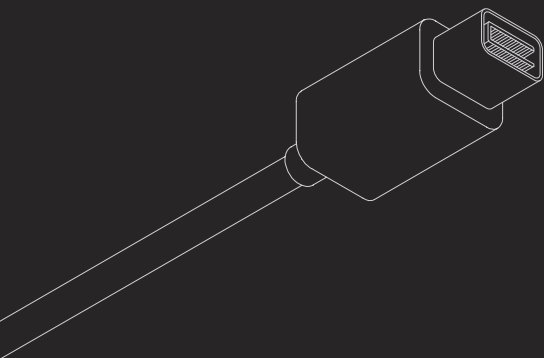
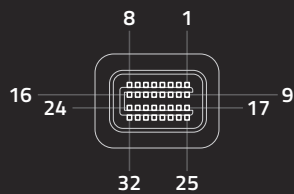
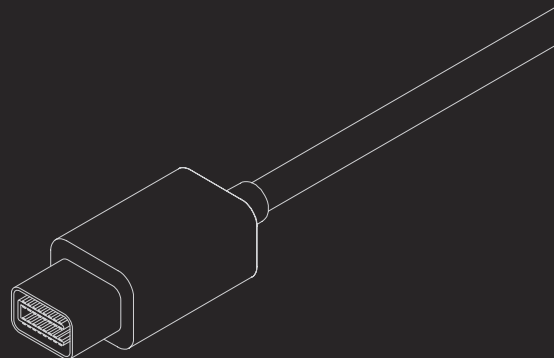
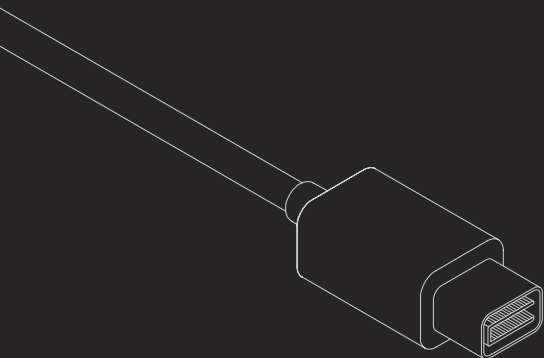

#	NAME	#	NAME
1	DATA2 +	17	+5V POWER
2	DATA2 -	18	DDC_DATA
3	DATA1 +	19	SPARE
4	DATA1 -	20	BLUE
5	DATA0 +	21	NOT INSTALLED
6	DATA0 -	22	GREEN
7	CLOCK +	23	NOT INSTALLED
8	CLOCK -	24	RED
9	DGND	25	DETECT
10	DGND	26	DDC_CLOCK
11	DGND	27	SPARE
12	DGND	28	DGND
13	DGND	29	HSYNC
14	DGND	30	DGND
15	DGND	31	VSYNC
16	DGND	32	DGND

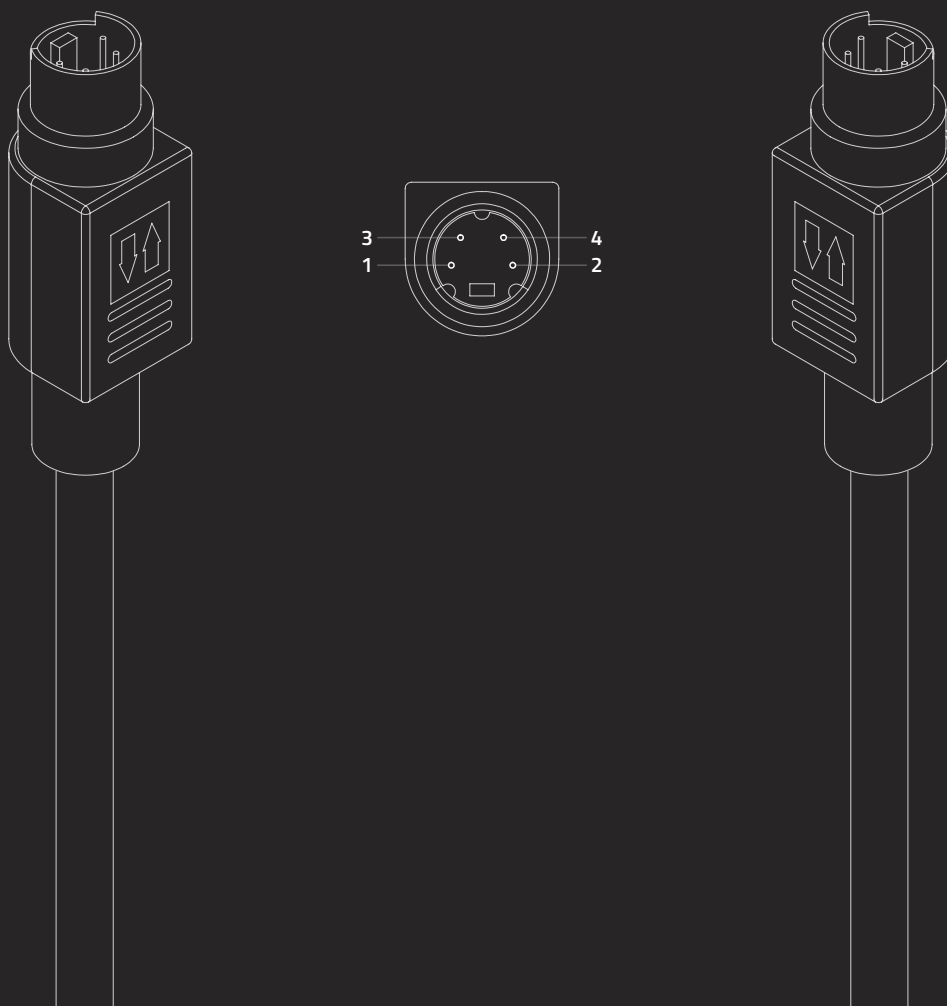

#	NAME	NOTES
1	GND	GROUND (Y)
2	GND	GROUND (C)
3	Y	INTENSITY (LUMINANCE)
4	C	COLOR (CHROMINANCE)

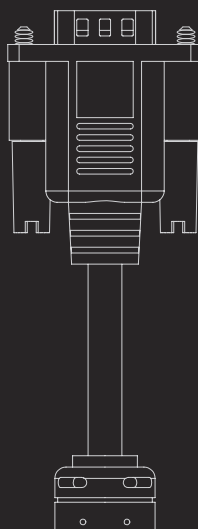
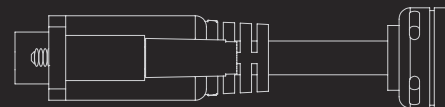
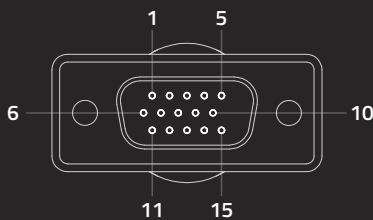
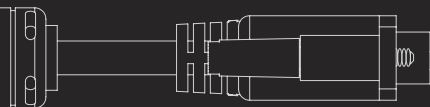
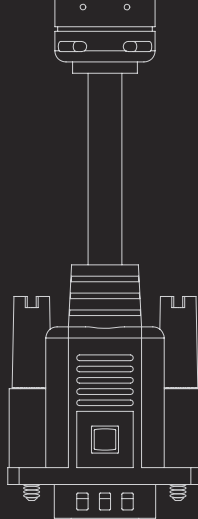



#	NAME	NOTES
1	RED	RED VIDEO
2	GREEN	GREEN VIDEO
3	BLUE	BLUE VIDEO
4	RES	RESERVED
5	GND	GROUND (HSYNC)
6	RED_RTN	RED RETURN
7	GREEN_RTN	GREEN RETURN
8	BLUE_RTN	BLUE RETURN
9	KEY/PWR	+5V POWER (50mA - 1A)
10	GND	GROUND (VSYNC)
11	RES	RESERVED
12	SDA	I2C DATA
13	HSYNC	HORIZONTAL SYNC
14	VSYNC	VERTICAL SYNC
15	SCL	I2C CLOCK

CONNECTORS / USB / USB TYPE MICRO-B 3.0

[PINOUTS.ORG/B01](http://PINOUTS.ORG/B01)

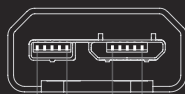
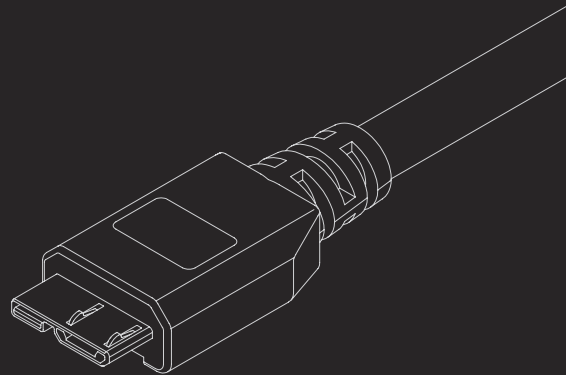
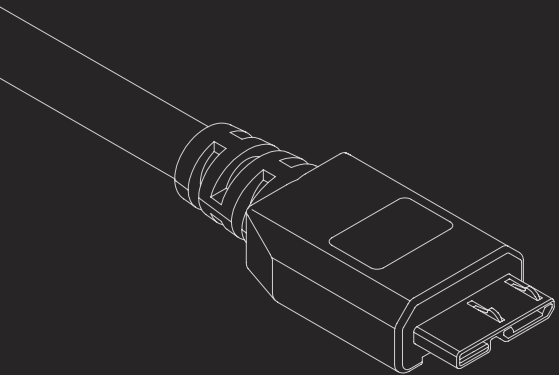

10 6 5 1

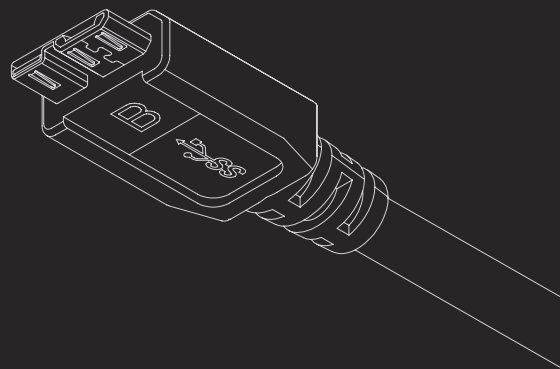
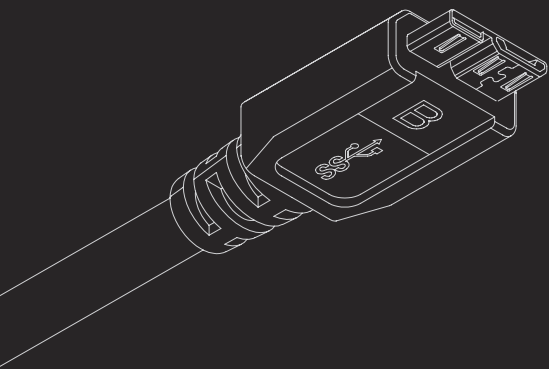

#	NAME	NOTES	WIRE COLOR
1	VBUS	5V POWER	RED
2	D-	USB 2.0 DIFFERENTIAL PAIR	WHITE
3	D+	USB 2.0 DIFFERENTIAL PAIR	GREEN
4	ID	OTG IDENTIFICATION	-
5	GND	GROUND FOR POWER RETURN	BLACK
6	MICB_SSTX-	SUPERSPEED TX DIFFERENTIAL PAIR	BLUE
7	MICB_SSTX+	SUPERSPEED TX DIFFERENTIAL PAIR	YELLOW
8	GND_DRAIN	GROUND FOR SUPERSPEED SIGNAL RETURN	GREY
9	MICB_SSRX-	SUPERSPEED RX DIFFERENTIAL PAIR	PURPLE
10	MICB_SSRX+	SUPERSPEED RX DIFFERENTIAL PAIR	ORANGE

*Note: TX and RS are defined from the device perspective*

CONNECTORS / USB / USB TYPE MICRO-B 2.0

[PINOUTS.ORG/B02](http://PINOUTS.ORG/B02)

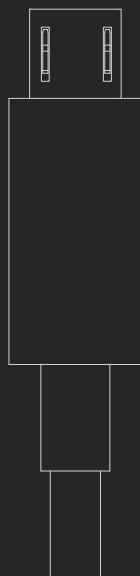
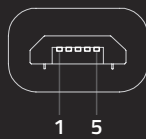
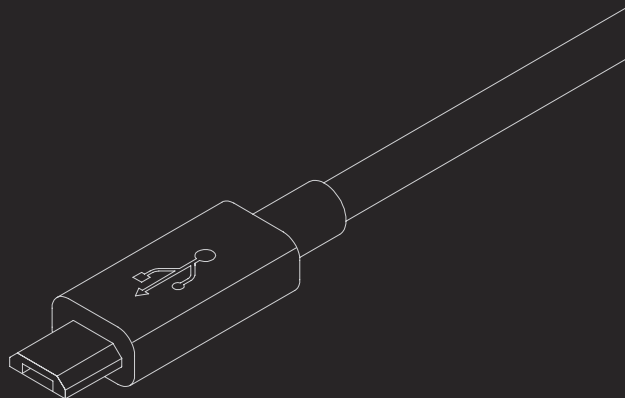
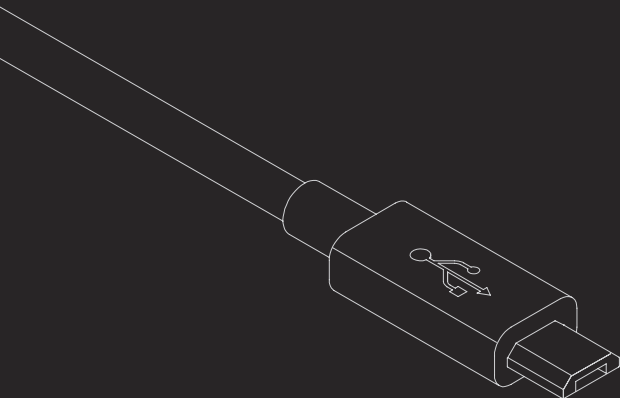

#	NAME	NOTES	WIRE COLOR
1	VBUS	5V POWER	RED
2	D-	DATA -	WHITE
3	D+	DATA +	GREEN
4	ID	OTG IDENTIFICATION	-
5	GND	GROUND	BLACK

*Note: The less common Micro-A 2.0 has the same pinout config*

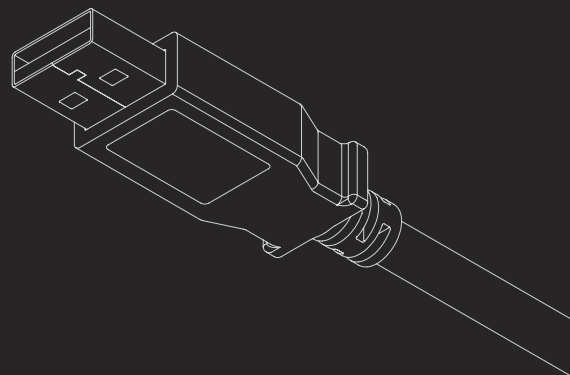
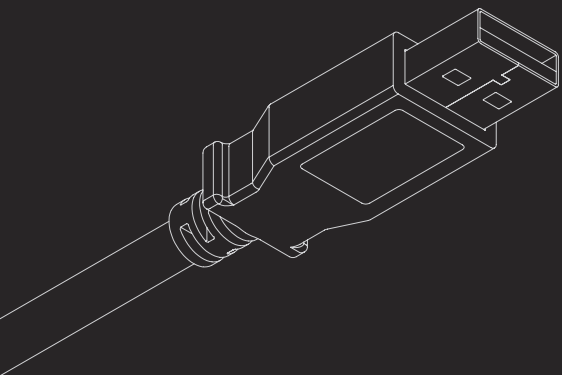
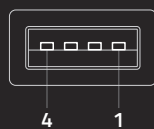
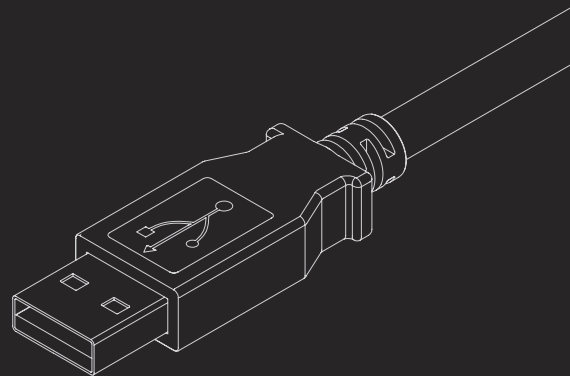
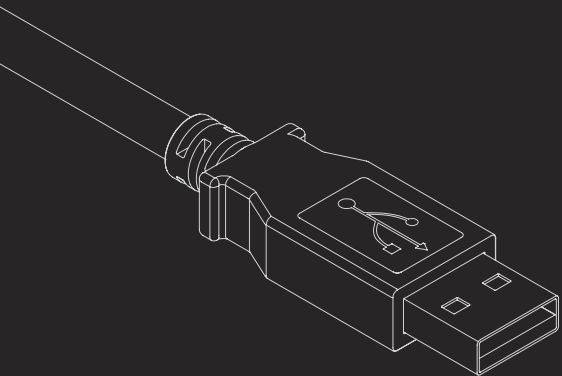

#	NAME	NOTES	WIRE COLOR
1	VBUS	5V POWER	RED
2	D-	DATA -	WHITE
3	D+	DATA +	GREEN
4	GND	GROUND	BLACK

CONNECTORS / USB / USB TYPE-A 3.0

[PINOUTS.ORG/B04](http://PINOUTS.ORG/B04)

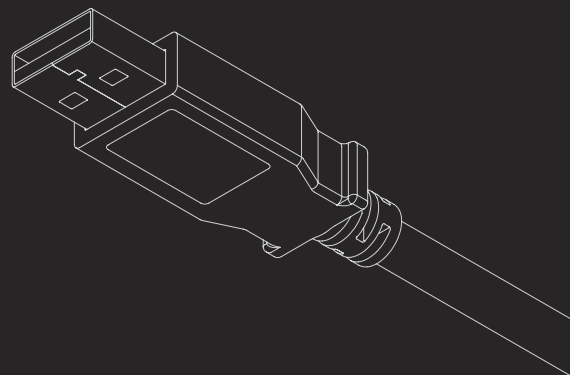
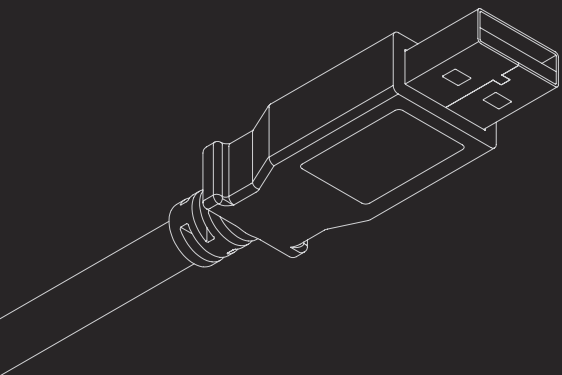
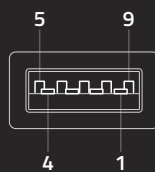
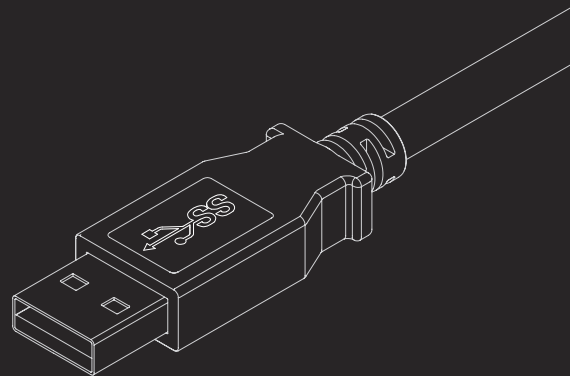
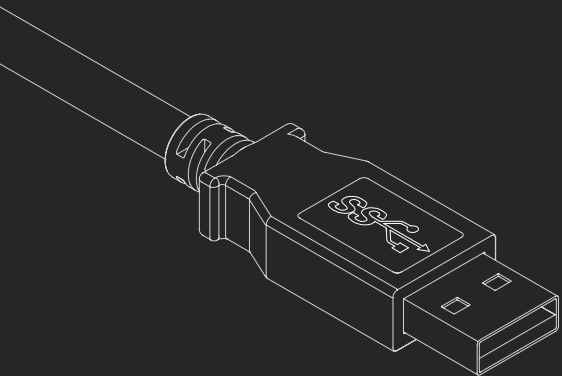



#	NAME	NOTES	WIRE COLOR
1	VBUS	5V POWER	RED
2	D-	USB 2.0 DIFFERENTIAL PAIR	WHITE
3	D+	USB 2.0 DIFFERENTIAL PAIR	GREEN
4	GND	GROUND FOR POWER RETURN	BLACK
5	STDA_SSRX-	SUPERSPEED RX DIFFERENTIAL PAIR	BLUE
6	STDA_SSRX+	SUPERSPEED RX DIFFERENTIAL PAIR	YELLOW
7	GND_DRAIN	GROUND FOR SUPERSPEED SIGNAL RETURN	GREY
8	STDA_SSTX-	SUPERSPEED TX DIFFERENTIAL PAIR	PURPLE
9	STDA_SSTX+	SUPERSPEED TX DIFFERENTIAL PAIR	ORANGE

*Note: TX and RS are defined from the host perspective*

CONNECTORS / USB / USB TYPE-B 2.0

[PINOUTS.ORG/B05](http://PINOUTS.ORG/B05)

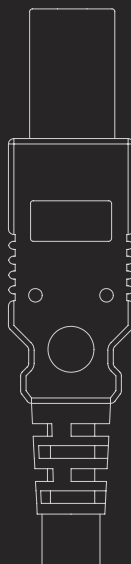
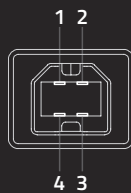
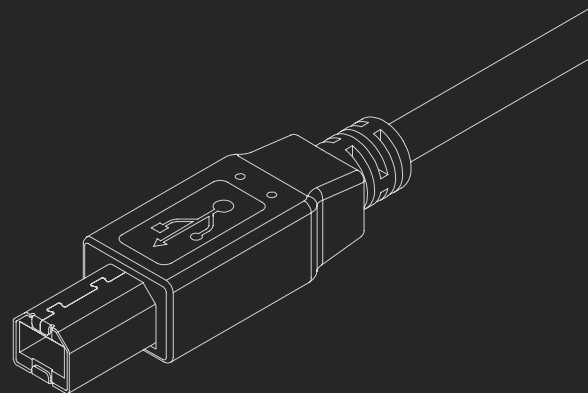
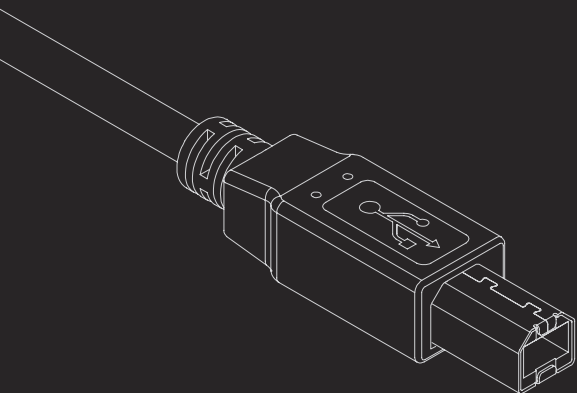

#	NAME	NOTES	WIRE COLOR
1	VBUS	5V POWER	RED
2	D-	DATA -	WHITE
3	D+	DATA +	GREEN
4	GND	GROUND	BLACK

CONNECTORS / USB / USB TYPE-B 3.0

[PINOUTS.ORG/B06](http://PINOUTS.ORG/B06)

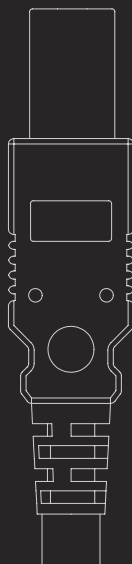
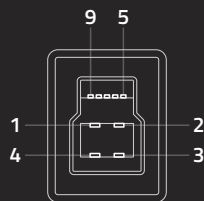
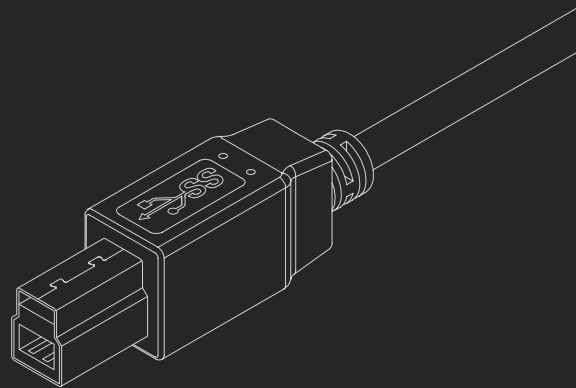
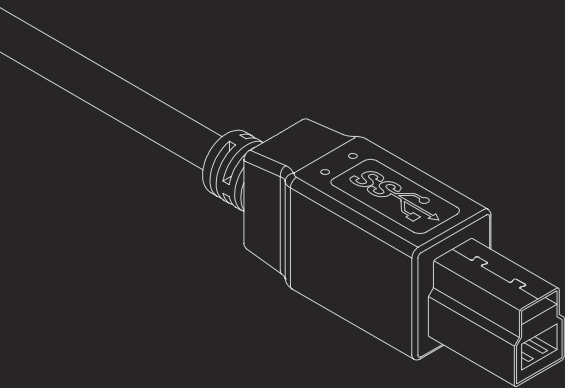

#	NAME	NOTES	WIRE COLOR
1	VBUS	5V POWER	RED
2	D-	USB 2.0 DIFFERENTIAL PAIR	WHITE
3	D+	USB 2.0 DIFFERENTIAL PAIR	GREEN
4	GND	GROUND FOR POWER RETURN	BLACK
5	STDB_SSTX-	SUPERSPEED TX DIFFERENTIAL PAIR	BLUE
6	STDB_SSTX+	SUPERSPEED TX DIFFERENTIAL PAIR	YELLOW
7	GND_DRAIN	GROUND FOR SUPERSPEED SIGNAL RETURN	GREY
8	STDB_SSRX-	SUPERSPEED RX DIFFERENTIAL PAIR	PURPLE
9	STDB_SSRX+	SUPERSPEED RX DIFFERENTIAL PAIR	ORANGE

*Note: TX and RS are defined from the device perspective*

CONNECTORS / USB / USB TYPE MINI-B 2.0

[PINOUTS.ORG/B07](http://PINOUTS.ORG/B07)

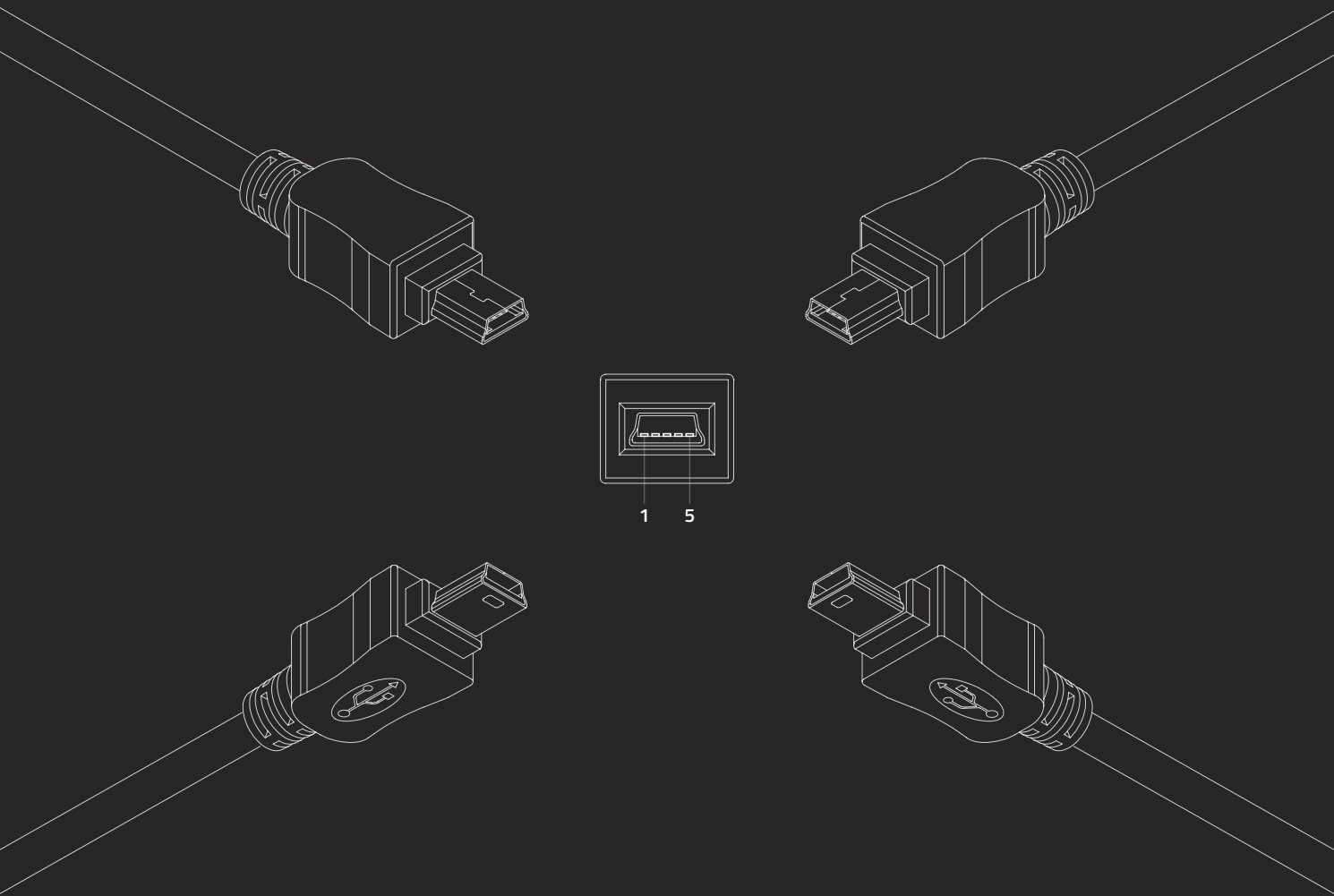

#	NAME	NOTES	WIRE COLOR
1	VBUS	5V POWER	RED
2	D-	DATA -	WHITE
3	D+	DATA +	GREEN
4	ID	OTG IDENTIFICATION	-
5	GND	GROUND	BLACK

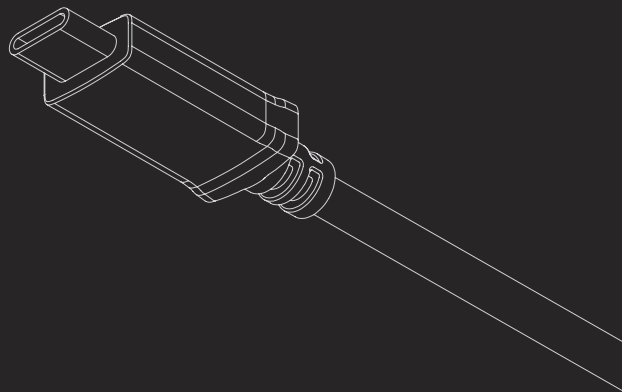
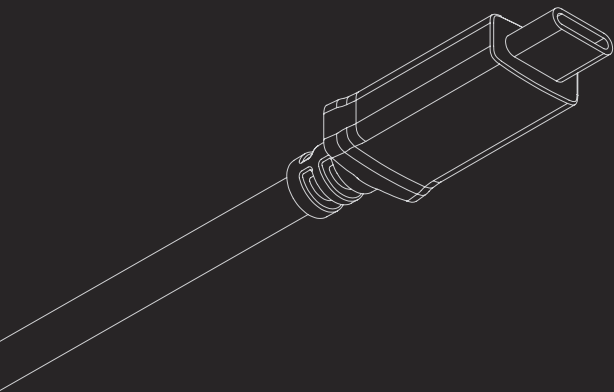
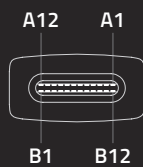
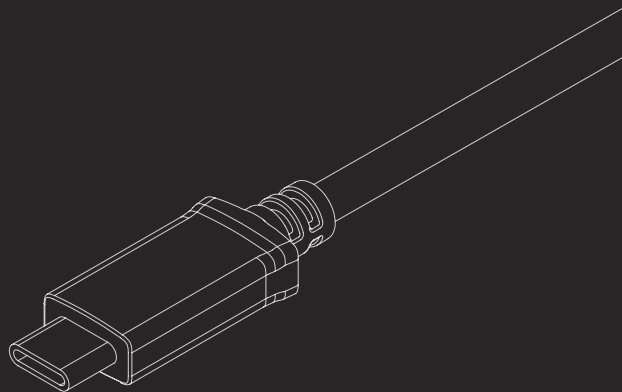
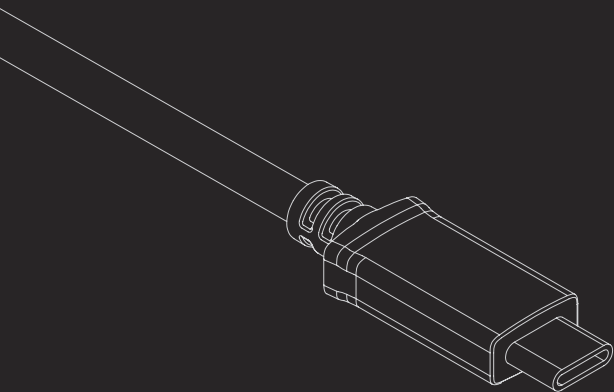



#	NAME	NOTES	#	NAME	NOTES
A1	GND	GROUND*	B1	GND	GROUND*
A2	TX1+	USB3.1 OR ALTERNATE MODE	B2	TX2+	USB3.1 OR ALTERNATE MODE
A3	TX1-	USB3.1 OR ALTERNATE MODE	B3	TX2-	USB3.1 OR ALTERNATE MODE
A4	VBUS	POWER*	B4	VBUS	POWER*
A5	CC1	CC OR VCONN	B5	CC2	CC OR VCONN
A6	D+	DATA+ (USB 2.0)	B6	D+	DATA+ (USB 2.0)
A7	D-	DATA- (USB 2.0)	B7	D-	DATA- (USB 2.0)
A8	SBU1	ALTERNATE MODE	B8	SBU2	ALTERNATE MODE
A9	VBUS	POWER*	B9	VBUS	POWER*
A10	RX2-	USB3.1 OR ALTERNATE MODE	B10	RX1-	USB3.1 OR ALTERNATE MODE
A11	RX2+	USB3.1 OR ALTERNATE MODE	B11	RX1+	USB3.1 OR ALTERNATE MODE
A12	GND	GROUND*	B12	GND	GROUND*

*\*Support for 60W minimum (combined with all VBUS pins)*

*Power Supply Options: USB 2.0 Nom Voltage 5V, Max 500mA | USB 3.0 / 3.1 Nom Voltage 5V, Max 900mA*

*USB BC1.2 Nom Voltage 5V, Max 1.5A | USB Type-C Current @ 1.5A Nom Voltage 5V, Max 1.5A*

*USB Type-C Current @ 2.0A Nom Voltage 5V, Max 3.0A | USB Power Delivery Nom Voltage Up to 20V, Up to 5A*

CONNECTORS / MISCELLANEOUS / ESATA

*PINOUTS.ORG/C01*

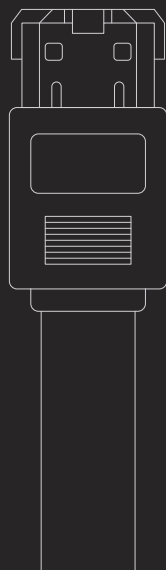
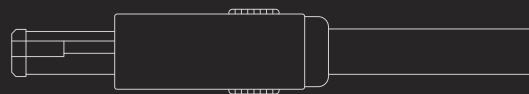
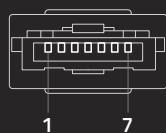
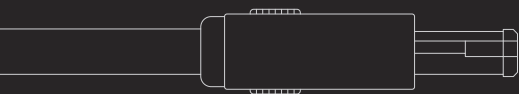
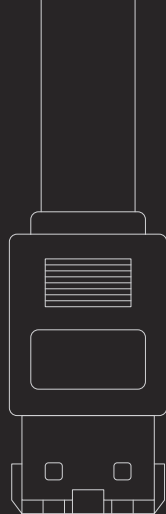

#	NAME	NOTES
1	GND	GROUND
2	A+	TRANSMIT +
3	A-	TRANSMIT -
4	GND	GROUND
5	B-	RECEIVE -
6	B+	RECEIVE +
7	GND	GROUND

CONNECTORS / MISCELLANEOUS / ETHERNET (RJ45)

*PINOUTS.ORG/C02*

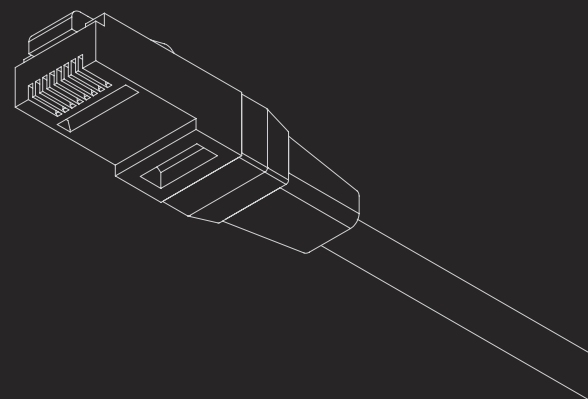
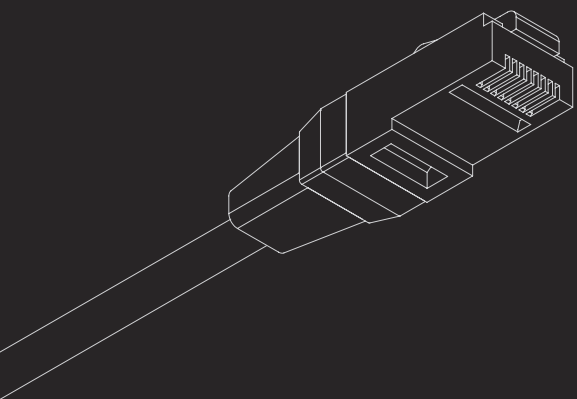
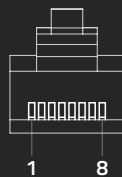
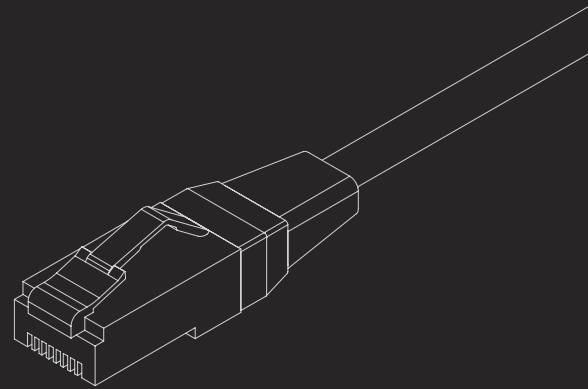
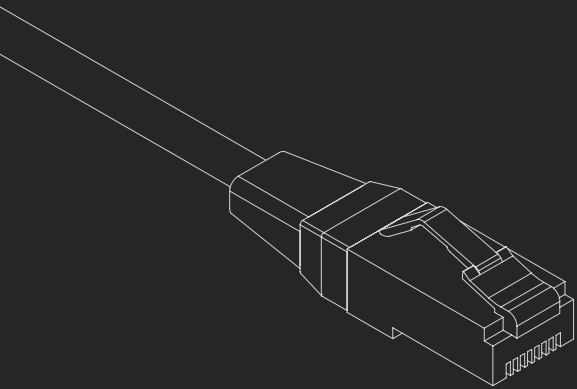

<i>T568A STANDARD</i>				
#	10BASE-T	100BASE-T	1000BASE-T	WIRE COLOR
1	TX+	TX+	BI_DA+	WHITE W/ GREEN STRIPE
2	TX-	TX-	BI_DA-	SOLID GREEN
3	RX+	RX+	BI_DB+	WHITE W/ ORANGE STRIPE
4	UNUSED	UNUSED	BI_DC+	SOLID BLUE
5	UNUSED	UNUSED	BI_DC-	WHITE W/ BLUE STRIPE
6	RX-	RX-	BI_DB-	SOLID ORANGE
7	UNUSED	UNUSED	BI_DD+	WHITE W/ BROWN STRIPE
8	UNUSED	UNUSED	BI_DD-	SOLID BROWN

<i>T568B STANDARD</i>				
#	10BASE-T	100BASE-T	1000BASE-T	WIRE COLOR
1	TX+	TX+	BI_DA+	WHITE W/ ORANGE STRIPE
2	TX-	TX-	BI_DA-	SOLID ORANGE
3	RX+	RX+	BI_DB+	WHITE W/ GREEN STRIPE
4	UNUSED	UNUSED	BI_DC+	SOLID BLUE
5	UNUSED	UNUSED	BI_DC-	WHITE W/ BLUE STRIPE
6	RX-	RX-	BI_DB-	SOLID GREEN
7	UNUSED	UNUSED	BI_DD+	WHITE W/ BROWN STRIPE
8	UNUSED	UNUSED	BI_DD-	SOLID BROWN

CONNECTORS / MISCELLANEOUS / FIREWIRE (6 PIN)

[PINOUTS.ORG/C03](http://PINOUTS.ORG/C03)

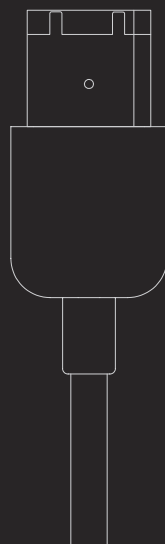
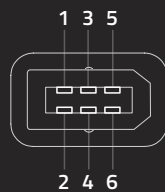
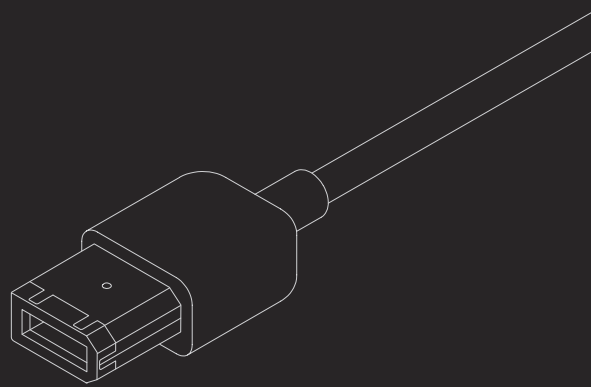
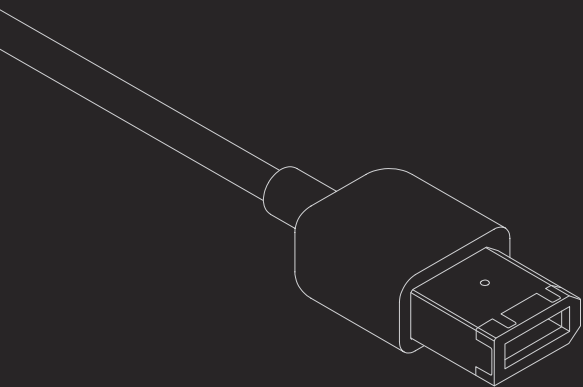

#	NAME	NOTES	WIRE COLOR
1	PWR	30V POWER	WHITE
2	GND	GROUND	BLACK
3	TPB-	TWISTED PAIR B	ORANGE
4	TPB+	TWISTED PAIR B	BLUE
5	TPA-	TWISTED PAIR A	RED
6	TPA+	TWISTED PAIR A	GREEN

CONNECTORS / MISCELLANEOUS / LIGHTNING CABLE

*PINOUTS.ORG/C04*

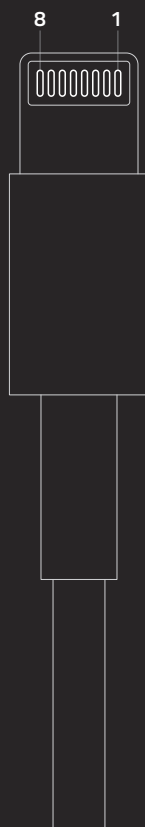
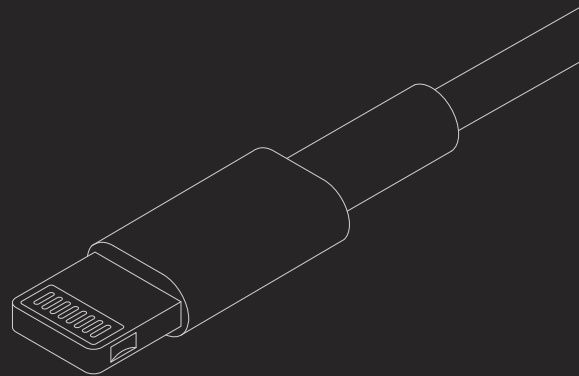
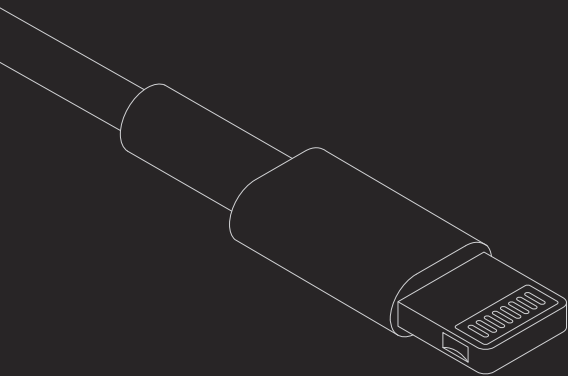



#	NAME	NOTES
1	GND	GROUND
2	LOP	LANE 0 +
3	LON	LANE 0 -
4	IDO	IDENTIFICATION/CONTROL 0
5	PWR	POWER (CHARGER OR BATTERY)
6	L1N	LANE 1 -
7	L1P	LANE 1 +
8	ID1	IDENTIFICATION/CONTROL 1

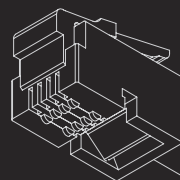
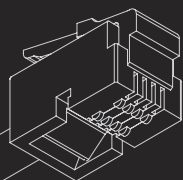
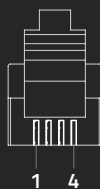
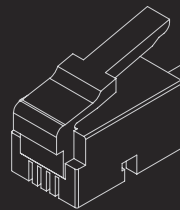
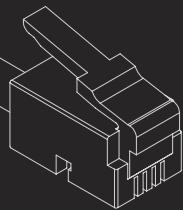

#	PAIR	RJ11	RJ14	WIRE COLOR	WIRE COLOR (OLD)
1	B		TX+	WHITE W/ ORANGE STRIPE	BLACK
2	A	RX-	RX-	BLUE W/ WHITE STRIPE	RED
3	A	TX+	TX+	WHITE W/ BLUE STRIPE	GREEN
4	B		RX-	ORANGE W/ WHITE STRIPE	YELLOW

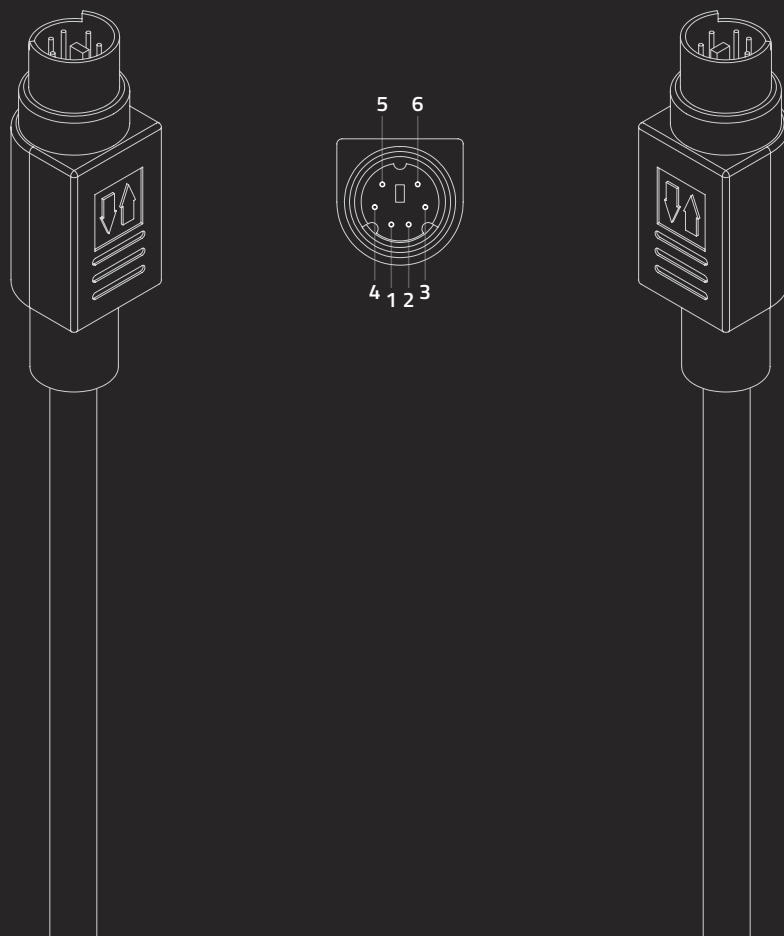

#	NAME	NOTES
1	DATA	KEY DATA
2	NC	NOT CONNECTED
3	GND	GROUND
4	VCC	+5V POWER
5	CLK	CLOCK
6	NC	NOT CONNECTED

CONNECTORS / MISCELLANEOUS / RS-232 SERIAL (DB25)

*PINOUTS.ORG/C07*

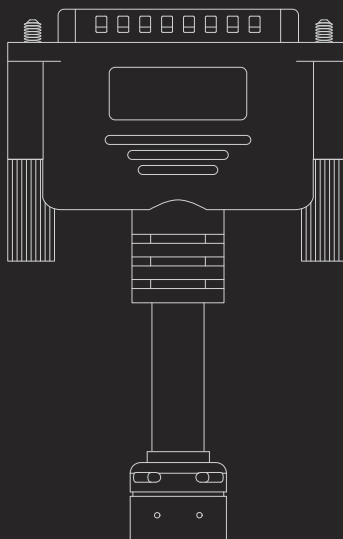
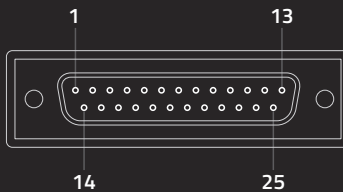
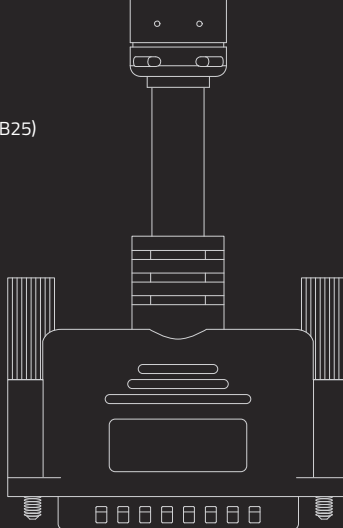

#	NAME	NOTES	#	NAME	NOTES
1	GND	SHIELD GROUND	14	S.TXD	SECONDARY TRANSMIT DATA
2	TXD	TRANSMIT DATA	15	TCK	TX SIGNAL ELEMENT TIMING
3	RXD	RECEIVE DATA	16	S.RXD	SECONDARY RECEIVE DATA
4	RTS	REQUEST TO SEND	17	RCK	RX SIGNAL ELEMENT TIMING
5	CTS	CLEAR TO SEND	18	LL	LOCAL LOOP CONTROL
6	DSR	DATA SET READY	19	S.RTS	SECONDARY REQUEST TO SEND
7	GND	SYSTEM GROUND	20	DTR	DATA TERMINAL READY
8	CD	CARRIER DETECT	21	RL	REMOTE LOOP CONTROL
9	-	RESERVED	22	RI	RING INDICATOR
10	-	RESERVED	23	DSR	DATA SIGNAL RATE SELECTOR
11	STF	SELECT TRANSMIT CHANNEL	24	XCK	TRANSMIT SIGNAL ELEMENT TIMING
12	S.CD	SECONDARY CARRIER DETECT	25	TI	TEST INDICATOR
13	S.CTS	SECONDARY CLEAR TO SEND			

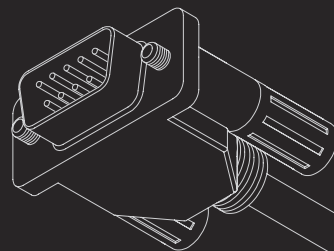
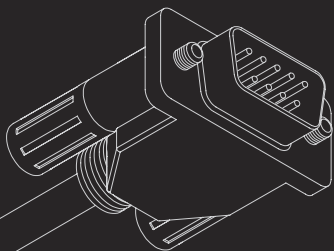
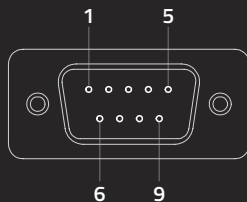
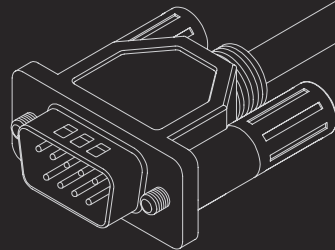
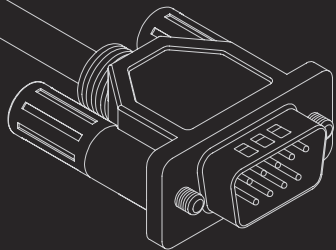



#	NAME	I/O	NOTES
1	DCD	IN	DATA CARRIER DETECT
2	RXD	IN	RECEIVE DATA
3	TXD	OUT	TRANSMIT DATA
4	DTR	OUT	DATA TERMINAL READY
5	GND	-	GROUND
6	DSR	IN	DATA SET READY
7	RTS	OUT	READY TO SEND
8	CTS	IN	CLEAR TO SEND
9	RI	IN	RING INDICATOR

MEMORY



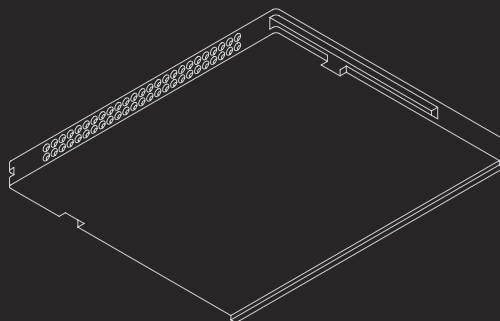
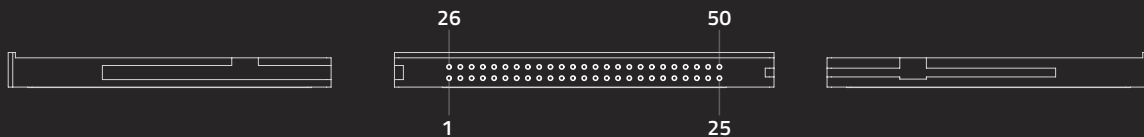
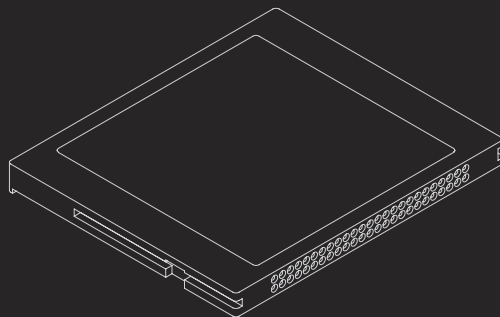

#	NAME	PIN TYPE	I/O TYPE
1	GND	-	GROUND
2	D03	I/O	I1Z, OZ3
3	D04	I/O	I1Z, OZ3
4	D05	I/O	I1Z, OZ3
5	D06	I/O	I1Z, OZ3
6	D07	I/O	I1Z, OZ3
7	-CS0	I	I3U
8	A10	I	I1Z
9	-ATA SEL	I	I3U
10	A09	I	I1Z
11	A08	I	I1Z
12	A07	I	I1Z
13	VCC	-	POWER
14	A06	I	I1Z
15	A05	I	I1Z
16	A04	I	I1Z
17	A03	I	I1Z
18	A02	I	I1Z
19	A01	I	I1Z
20	A00	I	I1Z
21	D00	I/O	I1Z, OZ3
22	D01	I/O	I1Z, OZ3
23	D02	I/O	I1Z, OZ3
24	WP	O	OT3
25	-CD2	O	GROUND

#	NAME	PIN TYPE	I/O TYPE
26	-CD1	O	GROUND
27	D11	I/O	I1Z, OZ3
28	D12	I/O	I1Z, OZ3
29	D13	I/O	I1Z, OZ3
30	D14	I/O	I1Z, OZ3
31	D15	I/O	I1Z, OZ3
32	-CE2	I	I3U
33	-VS1	O	GROUND
34	-IORD	I	I3U
35	-IOWR	I	I3U
36	-WE	I	I3U
37	READY	O	OT1
38	VCC	-	POWER
39	-CSEL	I	I2Z
40	-VS2	O	OPEN
41	RESET	I	I2Z
42	-WAIT	O	OT1
43	-INPACK	O	OT1
44	-REG	I	I3U
45	BVD2	O	OT1
46	BVD1	O	OT1
47	D08	I/O	I1Z, OZ3
48	D09	I/O	I1Z, OZ3
49	D10	I/O	I1Z, OZ3
50	GND	-	GROUND

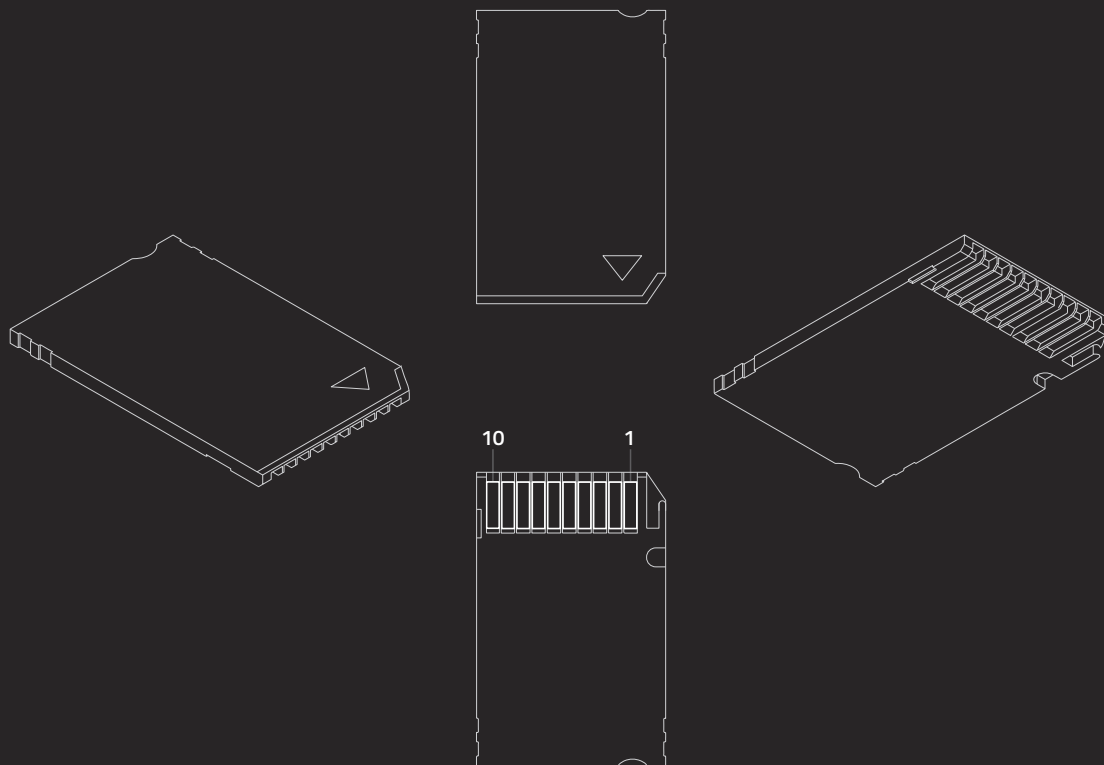

#	NAME	NOTES	TYPE
1	VSS	GROUND	-
2	BS	BUS STATE SIGNAL	I
3	DATA1	DATA1 PARALLEL / NC SERIAL	I/O
4	SDIO/DATA0	DATA0 PARALLEL / DATA SERIAL	I/O
5	DATA2	DATA2 PARALLEL / NC SERIAL	I/O
6	INS	STICK DETECT (CONNECTED TO VSS)	O
7	DATA3	DATA3 PARALLEL / NC SERIAL	I/O
8	SCLK	CLOCK SIGNAL	I
9	VCC	POWER SUPPLY (2.7V - 3.6V)	-
10	VSS	GROUND	-

*I: Input to Card, O: Output from Card, I/O: Bi-directional*

MEMORY / MEMORY CARDS / MICRO SD CARD

[PINOUTS.ORG/D03](http://PINOUTS.ORG/D03)

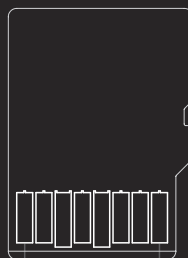
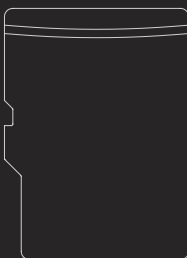
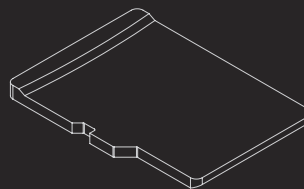
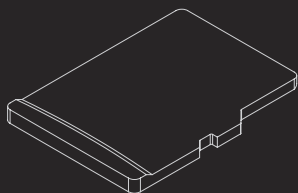

8

1

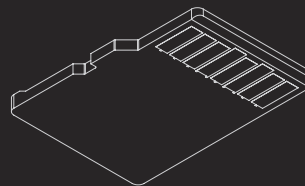
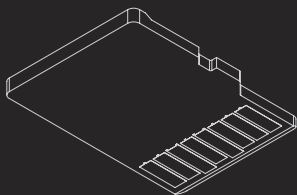



SD MODE		
#	NAME	NOTES
1	DAT2	DATA LINE (BIT 2)
2	DAT3	CARD DETECT
3	CMD	COMMAND/RESPONSE
4	VDD	POWER SUPPLY (3.3V*)
5	CLK	CLOCK
6	VSS	GROUND
7	DAT0	DATA LINE (BIT 0)
8	DAT1	DATA LINE (BIT 1)

SPI MODE		
#	NAME	NOTES
1	NC	NOT CONNECTED
2	CS	CHIP SELECT
3	DI	DATA INPUT
4	VDD	POWER SUPPLY (3.3V*)
5	SCLK	SERIAL CLOCK
6	VSS	GROUND
7	DO	DATA OUT
8	RSV	RESERVED

\* Some cards have an operating voltage range of 2.7V - 3.6V

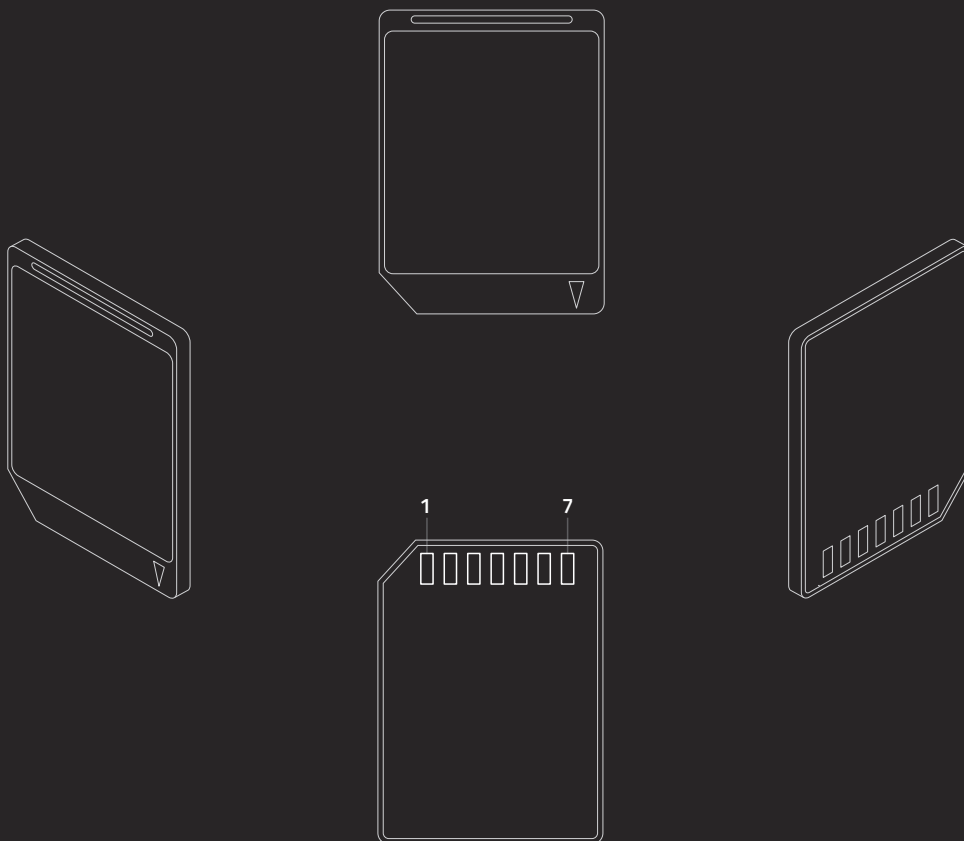

<i>MULTIMEDIACARD MODE</i>		
#	NAME	NOTES
1	RSV	RESERVED
2	CMD	COMMAND/RESPONSE
3	VSS1	GROUND
4	VCC	POWER SUPPLY
5	CLK	CLOCK
6	VSS2	GROUND
7	DAT	DATA LINE

<i>SPI MODE</i>		
#	NAME	NOTES
1	CS	CHIP SELECT
2	DI	DATA IN
3	VSS1	GROUND
4	VCC	POWER SUPPLY
5	SCLK	SERIAL CLOCK
6	VSS2	GROUND
7	DO	DATA OUT

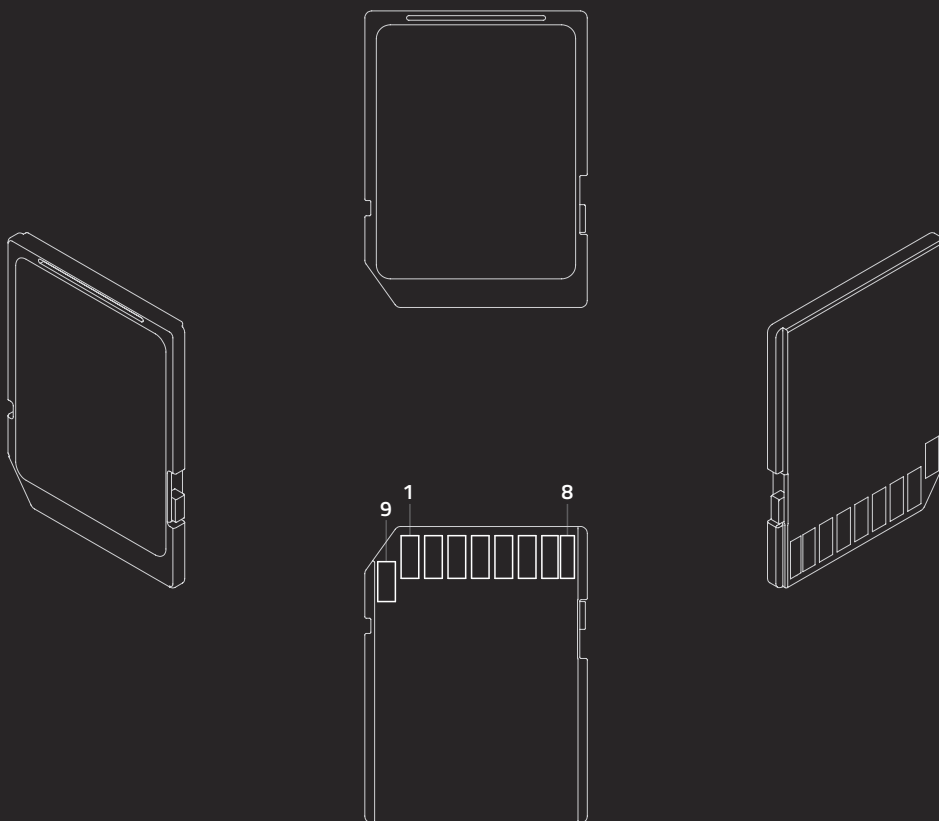

SD MODE		
#	NAME	NOTES
1	DAT3	DATA LINE (BIT 3)
2	CMD	COMMAND/RESPONSE
3	VSS1	GROUND
4	VDD	POWER SUPPLY (3.3V)
5	CLK	CLOCK
6	VSS	GROUND
7	DAT0	DATA LINE (BIT 0)
8	DAT1	DATA LINE (BIT 1)
9	DAT2	DATA LINE (BIT 2)

SPI MODE		
#	NAME	NOTES
1	CS	CHIP SELECT
2	DI	DATA IN
3	VSS1	GROUND
4	VDD	POWER SUPPLY (3.3V)
5	CLK	CLOCK
6	VSS	GROUND
7	DO	DATA OUT
8	NC	NOT CONNECTED
9	NC	NOT CONNECTED

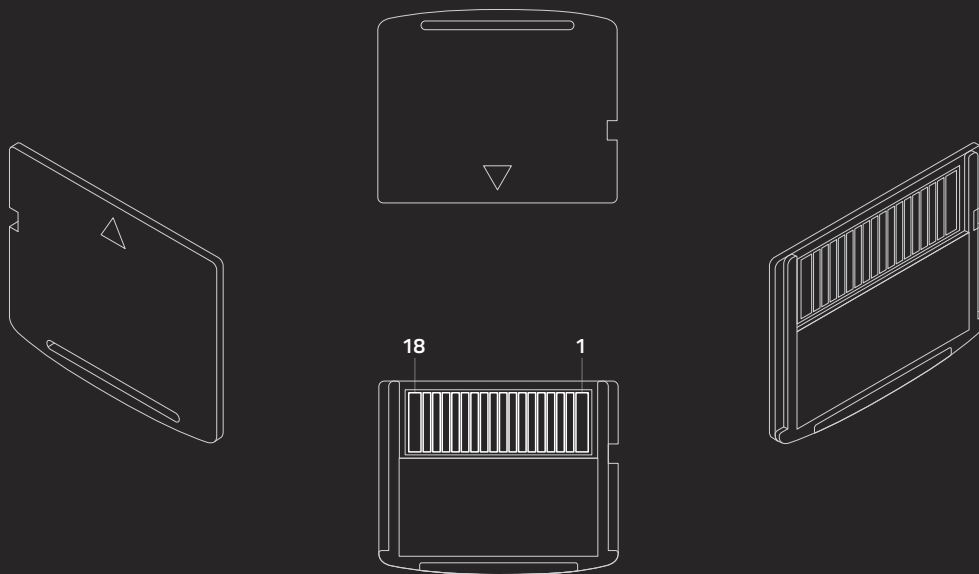

#	NAME	NOTES	TYPE	PULL UP/DOWN
1	GND	GROUND/(CARD DETECT)	(O)	-
2	R/-B	READY/BUSY	O (OD)	-
3	-RE	READ ENABLE	I	UP
4	-CE	CARD ENABLE	I	UP
5	CLE	COMMAND LATCH ENABLE	I	DOWN
6	ALE	ADDRESS LATCH ENABLE	I	DOWN
7	-WE	WRITE ENABLE	I	UP
8	-WP	WRITE PROTECT	I	DOWN
9	GND	GROUND	-	-
10	D0	DATA0	I/O	DOWN
11	D1	DATA1	I/O	DOWN
12	D2	DATA2	I/O	DOWN
13	D3	DATA3	I/O	DOWN
14	D4	DATA4	I/O	DOWN
15	D5	DATA5	I/O	DOWN
16	D6	DATA6	I/O	DOWN
17	D7	DATA7	I/O	DOWN
18	VCC	POWER SUPPLY	-	-

*I: Input to Card, O: Output from Card, I/O: Bi-directional, OD: Open drain*

BOARDS





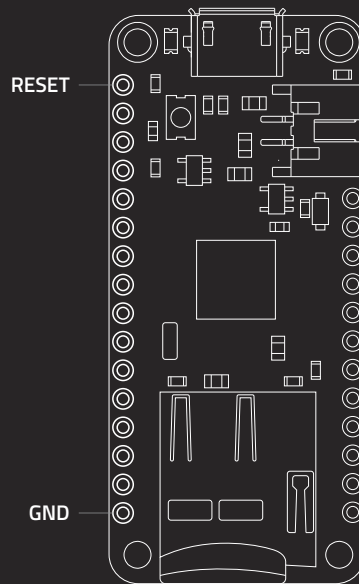

	NAME	PHYSICAL	PORT	SERIAL	ANALOG	INTERRUPT	IDE	SD CARD
⊙	RST	13						
⊙	3.3V							
⊙	AREF*	42						
⊙	GND							
⊙	A0	36	PF7	TDI	ADC7		18 / A0	
⊙	A1	37	PF6	TDO	ADC6		19 / A1	
⊙	A2	38	PF5	TMS	ADC5		20 / A2	
⊙	A3	39	PF4	TCK	ADC4		21 / A3	
⊙	A4	40	PF1		ADC1		22 / A4	
⊙	A5	41	PF0		ADC0		23 / A5	
⊙	SCK	9	PB1	SCLK		PCINT1	15	YES**
⊙	MOSI	10	PB2	MOSI/PDI		PCINT2	16	YES**
⊙	MISO	11	PB3	MISO/PDO		PCINT3	14	YES**
⊙	RX0	20	PD2	RXD1		INT2	0	
⊙	TX1	21	PD3	TXD1		INT3	1	
⊙	GND							

*Power: The total current of each port power group should not exceed 100mA. Absolute max per pin 20mA, 10mA recommended. Absolute max 200mA for the entire package.*

*\*AREF can't go higher than 3.3V. \*\*Pins also used by the SD Card. Refer to the datasheet for more information.*

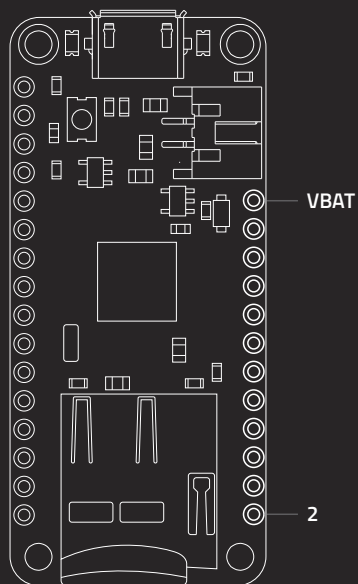

	NAME	PORT	PHYSICAL	PIN FUNCTION	INTERRUPT	SERIAL	ANALOG	IDE
⊙	VBAT*							
⊙	EN							
⊙	VBUS**							
⊙	13	PC7	32	CLK0 / OC4A / ICP3				13
⊙	12	PD6	26	T1 / OC4D			ADC9	12 / A11
⊙	11	PB7	12	OC1C / OC0A	PCINT7	RTS		11
⊙	10	PB6	30	OC1B / OC4B	PCINT6		ADC13	10 / A10
⊙	9	PB5	29	OC1A / OC4B	PCINT5		ADC12	9 / A9
⊙	6	PD7	27	T0 / OC4D			ADC10	6 / A7
⊙	5	PC6	31	OC3A / OC4A				5
⊙	3	PD0	18	OC0B	INT0	SCL		3
⊙	2	PD1	19		INT1	SDA		2

Power: \*VBAT is the positive voltage from JST battery jack. \*\*VBUS connected to 5V USB port. Absolute max 500mA.  
 The total current of each port power group should not exceed 100mA. Absolute max per pin 20mA, 10mA recommended. Absolute max 200mA for the entire package. 3V3 output from regulator max 400mA.

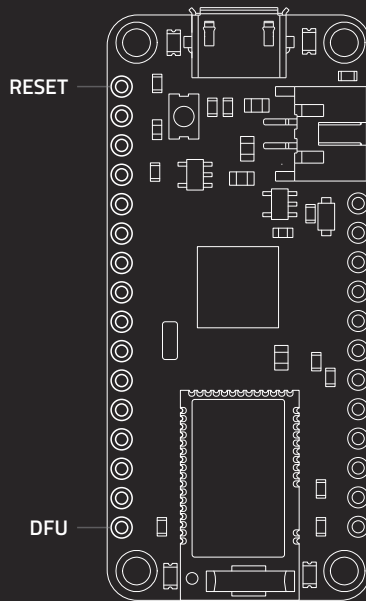

	NAME	PHYSICAL	PORT	SERIAL	ANALOG	INTERRUPT	IDE	BLE MODULE
⊙	RST	13						
⊙	3.3V							
⊙	AREF*	42						
⊙	GND							
⊙	A0	36	PF7	TDI	ADC7		18 / A0	
⊙	A1	37	PF6	TDO	ADC6		19 / A1	
⊙	A2	38	PF5	TMS	ADC5		20 / A2	
⊙	A3	39	PF4	TCK	ADC4		21 / A3	
⊙	A4	40	PF1		ADC1		22 / A4	
⊙	A5	41	PF0		ADC0		23 / A5	
⊙	SCK	9	PB1	SCLK		PCINT1	15	YES***
⊙	MOSI	10	PB2	MOSI/PDI		PCINT2	16	YES***
⊙	MISO	11	PB3	MISO/PDO		PCINT3	14	YES***
⊙	RX0	20	PD2	RXD1		INT2	0	
⊙	TX1	21	PD3	TXD1		INT3	1	
⊙	DFU**							

*Power: The total current of each port power group should not exceed 100mA. Absolute max per pin 20mA, 10mA recommended. Absolute max 200mA for the entire package.*

*\*AREF can't go higher than 3.3V. \*\*Used for BLE firmware update. Usually keep it disconnected. \*\*\*Pins also used by the BLE module. For more information refer to the datasheet.*

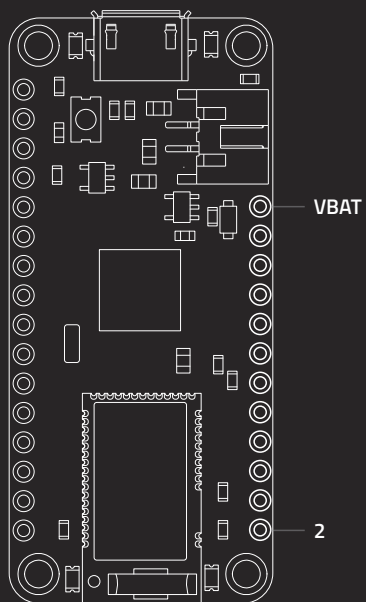



	NAME	PORT	PHYSICAL	PIN FUNCTION	INTERRUPT	SERIAL	ANALOG	IDE
⊙	VBAT*							
⊙	EN							
⊙	VBUS**							
⊙	13	PC7	32	CLK0 / OC4A / ICP3				13
⊙	12	PD6	26	T1 / OC4D			ADC9	12 / A11
⊙	11	PB7	12	OC1C / OC0A	PCINT7	RTS		11
⊙	10	PB6	30	OC1B / OC4B	PCINT6		ADC13	10 / A10
⊙	9	PB5	29	OC1A / OC4B	PCINT5		ADC12	9 / A9
⊙	6	PD7	27	T0 / OC4D			ADC10	6 / A7
⊙	5	PC6	31	OC3A / OC4A				5
⊙	3	PD0	18	OC0B	INT0	SCL		3
⊙	2	PD1	19		INT1	SDA		2

Power: \*VBAT is the positive voltage from JST battery jack. \*\*VBUS connected to 5V USB port. Absolute max 500mA.  
 The total current of each port power group should not exceed 100mA. Absolute max per pin 20mA, 10mA recommended. Absolute max 200mA for the entire package. 3V3 output from regulator max 400mA.

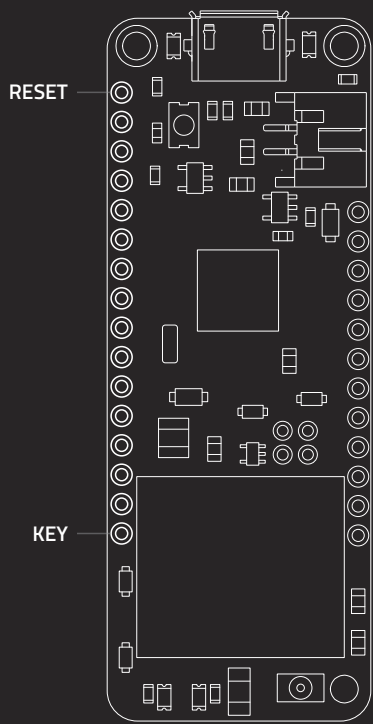

	NAME	PHYSICAL	PORT	SERIAL	ANALOG	INTERRUPT	IDE
⊙	RST	13					
⊙	3.3V						
⊙	AREF*	42					
⊙	GND						
⊙	A0	36	PF7	TDI	ADC7		18 / A0
⊙	A1	37	PF6	TDO	ADC6		19 / A1
⊙	A2	38	PF5	TMS	ADC5		20 / A2
⊙	A3	39	PF4	TCK	ADC4		21 / A3
⊙	A4	40	PF1		ADC1		22 / A4
⊙	A5	41	PF0		ADC0		23 / A5
⊙	SCK	9	PB1	SCLK		PCINT1	15
⊙	MOSI	10	PB2	MOSI/PDI		PCINT2	16
⊙	MISO	11	PB3	MISO/PDO		PCINT3	14
⊙	RX0	20	PD2	RXD1		INT2	0
⊙	TX1	21	PD3	TXD1		INT3	1
⊙	KEY**						

*Power: The total current of each port power group should not exceed 100mA. Absolute max per pin 20mA, 10mA recommended. Absolute max 200mA for the entire package.*

*\*AREF can't go higher than 3.3V. \*\*Manual module power control (cut the trace on bottom before).*

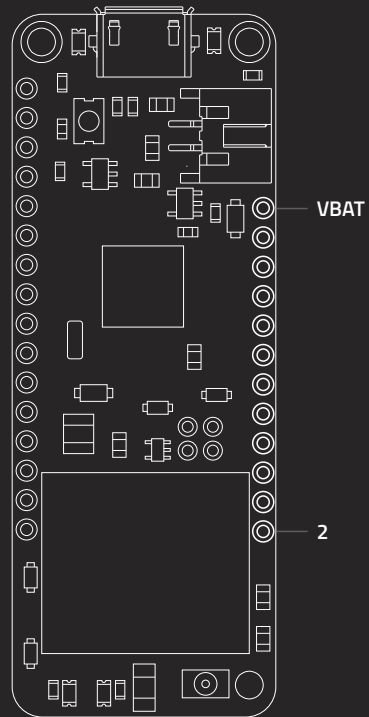

	NAME	PORT	PHYSICAL	PIN FUNCTION	INTERRUPT	SERIAL	ANALOG	IDE
⊙	VBAT*							
⊙	EN							
⊙	VBUS**							
⊙	13	PC7	32	CLK0 / OC4A / ICP3				13
⊙	12	PD6	26	T1 / OC4D			ADC9	12 / A11
⊙	11	PB7	12	OC1C / OC0A	PCINT7	RTS		11
⊙	10	PB6	30	OC1B / OC4B	PCINT6		ADC13	10 / A10
⊙	9	PB5	29	OC1A / OC4B	PCINT5		ADC12	9 / A9
⊙	6	PD7	27	T0 / OC4D			ADC10	6 / A7
⊙	5	PC6	31	OC3A / OC4A				5
⊙	3	PD0	18	OC0B	INT0	SCL		3
⊙	2	PD1	19		INT1	SDA		2

Power: \*VBAT is the positive voltage from JST battery jack. \*\*VBUS connected to 5V USB port. Absolute max 500mA.  
 The total current of each port power group should not exceed 100mA. Absolute max per pin 20mA, 10mA recommended. Absolute max 200mA for the entire package. 3V3 output from regulator max 400mA.

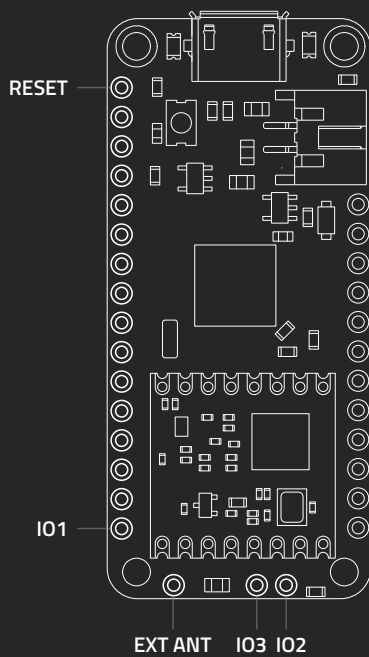

	NAME	PHYSICAL	PORT	SERIAL	ANALOG	INTERRUPT	IDE	RFM RADIO
⊙	RST	13						
⊙	3.3V							
⊙	AREF*	42						
⊙	GND							
⊙	A0	36	PF7	TDI	ADC7		18 / A0	
⊙	A1	37	PF6	TDO	ADC6		19 / A1	
⊙	A2	38	PF5	TMS	ADC5		20 / A2	
⊙	A3	39	PF4	TCK	ADC4		21 / A3	
⊙	A4	40	PF1		ADC1		22 / A4	
⊙	A5	41	PF0		ADC0		23 / A5	
⊙	SCK	9	PB1	SCLK		PCINT1	15	YES**
⊙	MOSI	10	PB2	MOSI/PDI		PCINT2	16	YES**
⊙	MISO	11	PB3	MISO/PDO		PCINT3	14	YES**
⊙	RX0	20	PD2	RXD1		INT2	0	
⊙	TX1	21	PD3	TXD1		INT3	1	
⊙	IO1							

*Power: The total current of each port power group should not exceed 100mA. Absolute max per pin 20mA, 10mA recommended. Absolute max 200mA for the entire package.*

*\*AREF can't go higher than 3.3V. \*\*These pins are also used by the radio module. Refer to the datasheet for more information.*

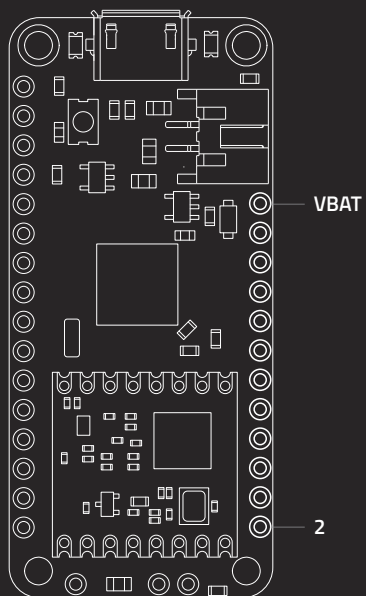



	NAME	PORT	PHYSICAL	PIN FUNCTION	INTERRUPT	SERIAL	ANALOG	IDE
⊙	VBAT*							
⊙	EN							
⊙	VBUS**							
⊙	13	PC7	32	CLK0 / OC4A / ICP3				13
⊙	12	PD6	26	T1 / OC4D			ADC9	12 / A11
⊙	11	PB7	12	OC1C / OC0A	PCINT7	RTS		11
⊙	10	PB6	30	OC1B / OC4B	PCINT6		ADC13	10 / A10
⊙	9	PB5	29	OC1A / OC4B	PCINT5		ADC12	9 / A9
⊙	6	PD7	27	T0 / OC4D			ADC10	6 / A7
⊙	5	PC6	31	OC3A / OC4A				5
⊙	3	PD0	18	OC0B	INT0	SCL		3
⊙	2	PD1	19		INT1	SDA		2

*Power: The total current of each port power group should not exceed 100mA. Absolute max per pin 20mA, 10mA recommended. Absolute max 200mA for the entire package. 3V3 output from regulator max 400mA.*

*\*VBAT is the positive voltage from JST battery jack. \*\*VBUS connected to 5V USB port. Absolute max 500mA.*

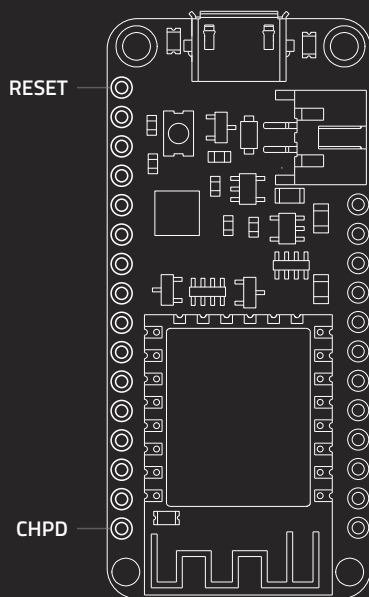

	NAME	PHYSICAL	PORT	PIN	SERIAL	ANALOG	IDE
⊙	RST	1					
⊙	3.3V						
⊙	NC						
⊙	GND						
⊙	ADC	2	ADC	TOUT		ADC	17 / A0
⊙	NC						
⊙	NC						
⊙	NC						
⊙	NC						
⊙	NC						
⊙	SCK	5	IO14		SCLK / HSPI (CLK)		14
⊙	MOSI	7	IO13		MOSI / CTS0 / HSPI (D) / RXD2		13
⊙	MISO	6	IO12		MISO / HSPI(Q)		12
⊙	RX	15	IO3		RX / RXD0		3
⊙	TX	16	IO1		TX / CS1 / TXD0		1
⊙	CHPD	3					

Power: Absolute maximum current per pin 12mA, 6mA recommended. Absolute maximum 85mA for the entire package

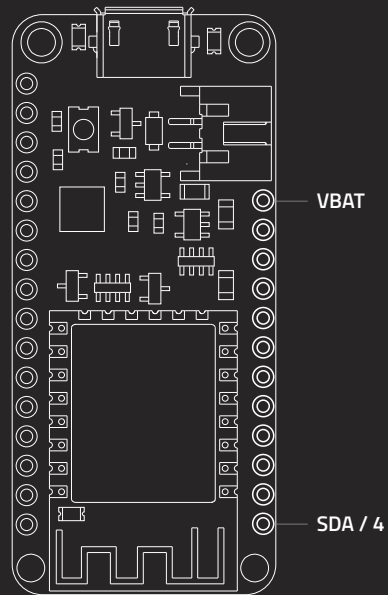

	NAME	PHYSICAL	PORT	PIN	SERIAL	IDE
⊙	VBAT*					
⊙	EN					
⊙	VBUS**					
⊙	14	5	I014		HSPI (CLK) / SCK	14
⊙	12	6	I012		HSPI (Q) / MISO	12
⊙	13	7	I013		RXD2 / HSPI (D) / MOSI	13
⊙	15	10	I015		TXD2 / HSPI (CS) / RTS0	15
⊙	0	12	I00		CS2	0
⊙	16	4	I016	WAKE		16
⊙	2	11	I02		TXD1	2
⊙	SCL / 5	14	I05		SCL	5
⊙	SDA / 4	13	I04		SDA	4

*Power: Absolute maximum current per pin 12mA, 6mA recommended. Absolute maximum 85mA for the entire package. 3V3 output from regulator (max 400mA).*

*\*VBAT is the positive voltage from the JST battery jack. \*\*VBUS is connected to the 5V USB port. Absolute maximum current 500mA.*

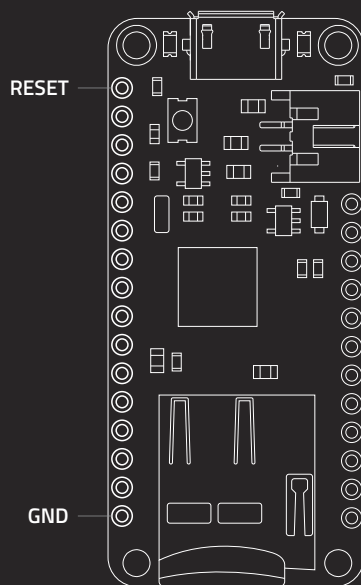

	NAME	PHYSICAL	PORT	INTERRUPT	SERIAL	ANALOG	IDE	SD CARD
⊙	RESET	40						
⊙	3.3V							
⊙	AREF*	4	PA03	EINT3		AIN1 / VREF A		
⊙	GND							
⊙	A0	3	PA02	EINT2		AIN0 / DAC	14 / A0	
⊙	A1	7	PB08	EINT8	S 4:0	AIN2	15 / A1	
⊙	A2	8	PB09	EINT9	S 4:1	AIN3	16 / A2	
⊙	A3	9	PA04	EINT4	S 0:0	AIN4 / VREF B	17 / A3	
⊙	A4	10	PA05	EINT5	S 0:1	AIN5	18 / A4	
⊙	A5	47	PB02	EINT2	S 5:0	AIN10	19 / A5	
⊙	SCK	20	PB11	EINT11	SCK / S 4:3 / I2SCL		24	YES**
⊙	MOSI	19	PB10	EINT10	MOSI / S 4:2 / I2SMC		23	YES**
⊙	MISO	21	PA12		MISO / S2 4:0 / I2C		22	YES**
⊙	RX0	16	PA11	EINT11	RX / S 02:3 / I2SF0		0	
⊙	TX1	15	PA10	EINT10	TX / S 02:2 / I2SCK		1	
⊙	GND							

*Power: The total current of each port power group should not exceed 65mA. Absolute maximum current per pin 10mA, 7mA recommended. Absolute maximum 130mA for the entire package.*

*\*AREF can't go higher than 3.3V \*\*Pins also used by SD card module. Refer to datasheet for more information.*

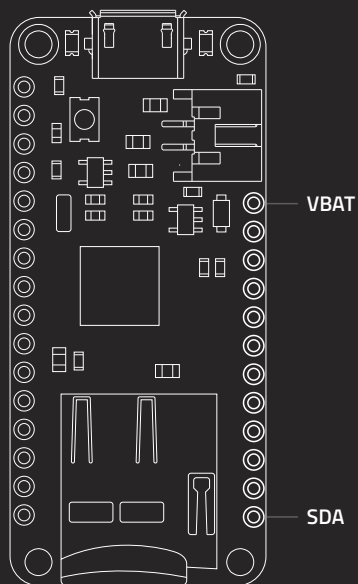



	NAME	PHYSICAL	PORT	INTERRUPT	SERIAL	ANALOG	IDE
⊙	VBAT*						
⊙	EN						
⊙	VBUS**						
⊙	13	26	PA17	EINT1	I2C / S1 3:1		13
⊙	12	28	PA19	EINT3	I2SD0 / S1 3:3		12
⊙	11	25	PA16	EINT0	I2C / S1 3:0		11
⊙	10	27	PA18	EINT2	S1 3:2		10
⊙	9	12	PA07	EINT7	I2SD0 / S0:3	AIN7	9 / A7
⊙	6	29	PA20	EINT4	I2SSC / S3 5:2		6
⊙	5	24	PA15	EINT15	S2 4:3		5
⊙	SCL	32	PA23	EINT7	I2C / S3 5:1 / SCL		21
⊙	SDA	31	PA22	EINT6	I2C / S3 5:0 / SDA		20

*Power: The total current of each port power group should not exceed 65mA. Absolute maximum current per pin 10mA, 7mA recommended. Absolute maximum 130mA for the entire package.*

*\*VBAT is the positive voltage from the JST battery jack. \*\*VBUS is connected to the 5V USB port. Absolute maximum current 500mA.*

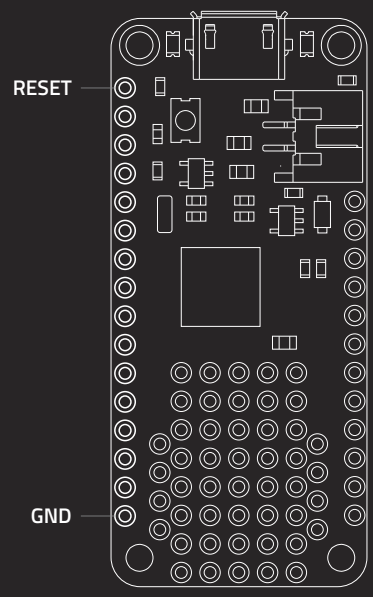

	NAME	PHYSICAL	PORT	INTERRUPT	SERIAL	ANALOG	IDE
⊙	RESET	40					
⊙	3.3V						
⊙	AREF*	4	PA03	EINT3		AIN1 / VREF A	
⊙	GND						
⊙	A0	3	PA02	EINT2		AIN0 / DAC	14 / A0
⊙	A1	7	PB08	EINT8	S 4:0	AIN2	15 / A1
⊙	A2	8	PB09	EINT9	S 4:1	AIN3	16 / A2
⊙	A3	9	PA04	EINT4	S 0:0	AIN4 / VREF B	17 / A3
⊙	A4	10	PA05	EINT5	S 0:1	AIN5	18 / A4
⊙	A5	47	PB02	EINT2	S 5:0	AIN10	19 / A5
⊙	SCK	20	PB11	EINT11	SCK / S 4:3 / I2SCL		24
⊙	MOSI	19	PB10	EINT10	MOSI / S 4:2 / I2SMC		23
⊙	MISO	21	PA12		MISO / S2 4:0 / I2C		22
⊙	RX0	16	PA11	EINT11	RX / S 02:3 / I2SFO		0
⊙	TX1	15	PA10	EINT10	TX / S 02:2 / I2SCK		1
⊙	GND						

*Power: The total current of each port power group should not exceed 65mA. Absolute maximum current per pin 10mA, 7mA recommended. Absolute maximum 130mA for the entire package.*

*\*AREF can't go higher than 3.3V*

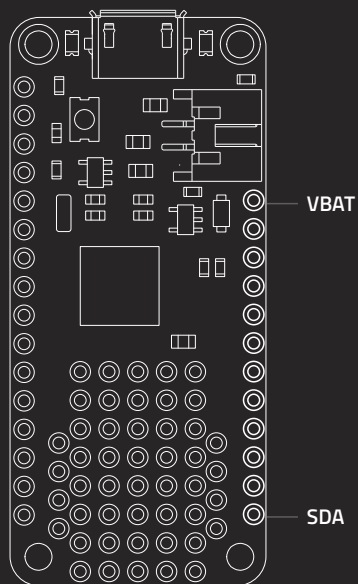

	NAME	PHYSICAL	PORT	INTERRUPT	SERIAL	ANALOG	IDE
⊙	VBAT*						
⊙	EN						
⊙	VBUS**						
⊙	13	26	PA17	EINT1	I2C / S1 3:1		13
⊙	12	28	PA19	EINT3	I2SD0 / S1 3:3		12
⊙	11	25	PA16	EINT0	I2C / S1 3:0		11
⊙	10	27	PA18	EINT2	S1 3:2		10
⊙	9	12	PA07	EINT7	I2SD0 / S0:3	AIN7	9 / A7
⊙	6	29	PA20	EINT4	I2SSC / S3 5:2		6
⊙	5	24	PA15	EINT15	S2 4:3		5
⊙	SCL	32	PA23	EINT7	I2C / S3 5:1 / SCL		21
⊙	SDA	31	PA22	EINT6	I2C / S3 5:0 / SDA		20

*Power: The total current of each port power group should not exceed 65mA. Absolute maximum current per pin 10mA, 7mA recommended. Absolute maximum 130mA for the entire package.*

*\*VBAT is the positive voltage from the JST battery jack. \*\*VBUS is connected to the 5V USB port. Absolute maximum current 500mA.*

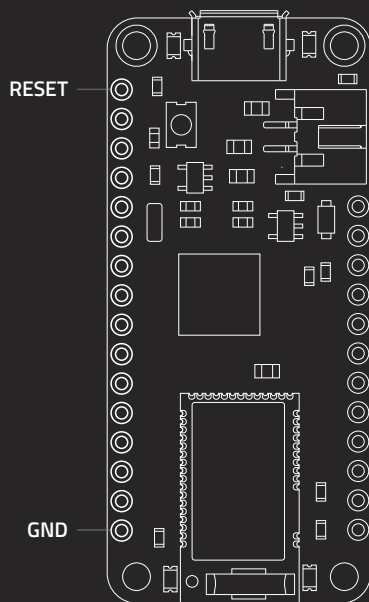

	NAME	PHYSICAL	PORT	INTERRUPT	SERIAL	ANALOG	IDE	BLE
⊙	RESET	40						
⊙	3.3V							
⊙	AREF*	4	PA03	EINT3		AIN1 / VREF A		
⊙	GND							
⊙	A0	3	PA02	EINT2		AIN0 / DAC	14 / A0	
⊙	A1	7	PB08	EINT8	S 4:0	AIN2	15 / A1	
⊙	A2	8	PB09	EINT9	S 4:1	AIN3	16 / A2	
⊙	A3	9	PA04	EINT4	S 0:0	AIN4 / VREF B	17 / A3	
⊙	A4	10	PA05	EINT5	S 0:1	AIN5	18 / A4	
⊙	A5	47	PB02	EINT2	S 5:0	AIN10	19 / A5	
⊙	SCK	20	PB11	EINT11	SCK / S 4:3 / I2SCL		24	YES**
⊙	MOSI	19	PB10	EINT10	MOSI / S 4:2 / I2SMC		23	YES**
⊙	MISO	21	PA12		MISO / S2 4:0 / I2C		22	YES**
⊙	RX0	16	PA11	EINT11	RX / S 02:3 / I2SF0		0	
⊙	TX1	15	PA10	EINT10	TX / S 02:2 / I2SCK		1	
⊙	GND							

*Power: The total current of each port power group should not exceed 65mA. Absolute maximum current per pin 10mA, 7mA recommended. Absolute maximum 130mA for the entire package.*

*\*AREF can't go higher than 3.3V \*\*Pins also used by BLE radio module. Refer to datasheet for more information.*

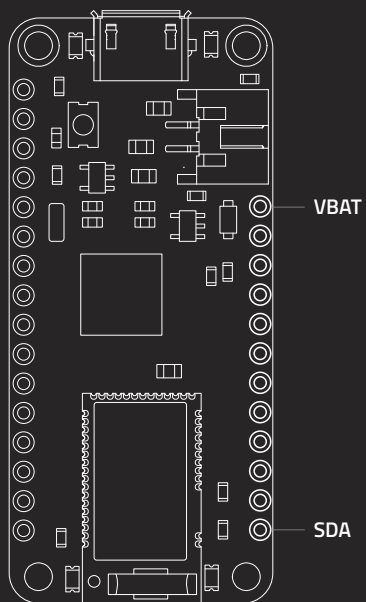



	NAME	PHYSICAL	PORT	INTERRUPT	SERIAL	ANALOG	IDE
⊙	VBAT*						
⊙	EN						
⊙	VBUS**						
⊙	13	26	PA17	EINT1	I2C / S1 3:1		13
⊙	12	28	PA19	EINT3	I2SD0 / S1 3:3		12
⊙	11	25	PA16	EINT0	I2C / S1 3:0		11
⊙	10	27	PA18	EINT2	S1 3:2		10
⊙	9	12	PA07	EINT7	I2SD0 / S0:3	AIN7	9 / A7
⊙	6	29	PA20	EINT4	I2SSC / S3 5:2		6
⊙	5	24	PA15	EINT15	S2 4:3		5
⊙	SCL	32	PA23	EINT7	I2C / S3 5:1 / SCL		21
⊙	SDA	31	PA22	EINT6	I2C / S3 5:0 / SDA		20

*Power: The total current of each port power group should not exceed 65mA. Absolute maximum current per pin 10mA, 7mA recommended. Absolute maximum 130mA for the entire package.*

*\*VBAT is the positive voltage from the JST battery jack. \*\*VBUS is connected to the 5V USB port. Absolute maximum current 500mA.*

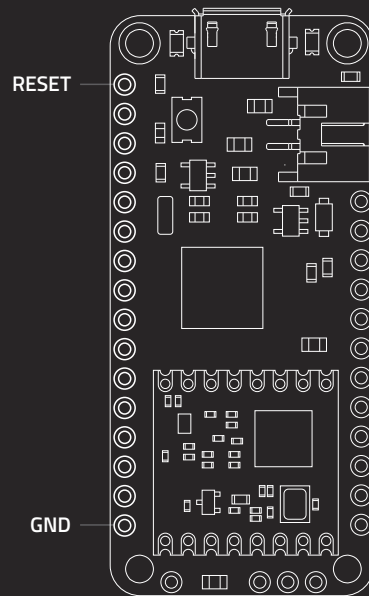

	NAME	PHYSICAL	PORT	INTERRUPT	SERIAL	ANALOG	IDE	RFM
⊙	RESET	40						
⊙	3.3V							
⊙	AREF*	4	PA03	EINT3		AIN1 / VREF A		
⊙	GND							
⊙	A0	3	PA02	EINT2		AIN0 / DAC	14 / A0	
⊙	A1	7	PB08	EINT8	S 4:0	AIN2	15 / A1	
⊙	A2	8	PB09	EINT9	S 4:1	AIN3	16 / A2	
⊙	A3	9	PA04	EINT4	S 0:0	AIN4 / VREF B	17 / A3	
⊙	A4	10	PA05	EINT5	S 0:1	AIN5	18 / A4	
⊙	A5	47	PB02	EINT2	S 5:0	AIN10	19 / A5	
⊙	SCK	20	PB11	EINT11	SCK / S 4:3 / I2SCL		24	YES**
⊙	MOSI	19	PB10	EINT10	MOSI / S 4:2 / I2SMC		23	YES**
⊙	MISO	21	PA12		MISO / S2 4:0 / I2C		22	YES**
⊙	RX0	16	PA11	EINT11	RX / S 02:3 / I2SF0		0	
⊙	TX1	15	PA10	EINT10	TX / S 02:2 / I2SCK		1	
⊙	GND							

*Power: The total current of each port power group should not exceed 65mA. Absolute maximum current per pin 10mA, 7mA recommended. Absolute maximum 130mA for the entire package.*

*\*AREF can't go higher than 3.3V \*\*Pins also used by RFM radio module. Refer to datasheet for more information.*

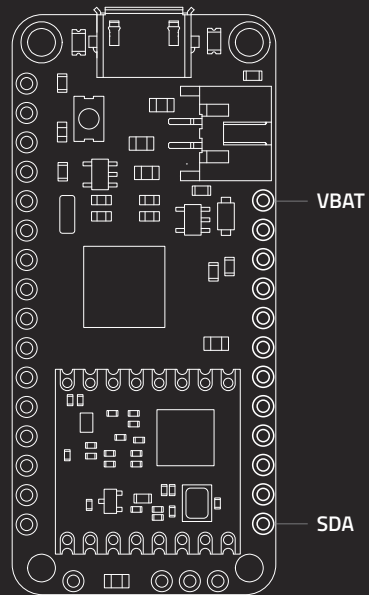

	NAME	PHYSICAL	PORT	INTERRUPT	SERIAL	ANALOG	IDE
⊙	VBAT*						
⊙	EN						
⊙	VBUS**						
⊙	13	26	PA17	EINT1	I2C / S1 3:1		13
⊙	12	28	PA19	EINT3	I2SD0 / S1 3:3		12
⊙	11	25	PA16	EINT0	I2C / S1 3:0		11
⊙	10	27	PA18	EINT2	S1 3:2		10
⊙	9	12	PA07	EINT7	I2SD0 / S0:3	AIN7	9 / A7
⊙	6	29	PA20	EINT4	I2SSC / S3 5:2		6
⊙	5	24	PA15	EINT15	S2 4:3		5
⊙	SCL	32	PA23	EINT7	I2C / S3 5:1 / SCL		21
⊙	SDA	31	PA22	EINT6	I2C / S3 5:0 / SDA		20

*Power: The total current of each port power group should not exceed 65mA. Absolute maximum current per pin 10mA, 7mA recommended. Absolute maximum 130mA for the entire package.*

*\*VBAT is the positive voltage from the JST battery jack. \*\*VBUS is connected to the 5V USB port. Absolute maximum current 500mA.*

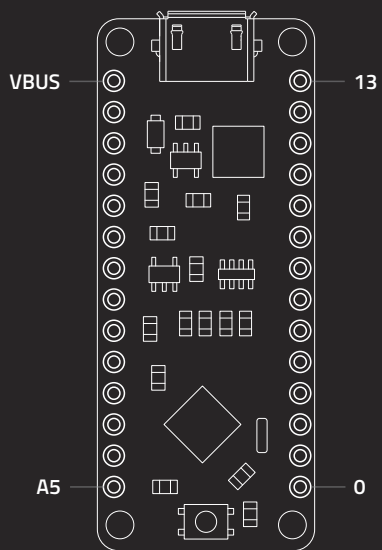



NAME	ARDUINO	GPIO	CIRCUITPYTHON	OTHER
VBUS				
RESET				
3.3V				
5V				
GND				
GND				
VIN				
AREF			AREF	
A0	14	PC0	AD0	
A1	15	PC1	AD1	
A2	16	PC2	AD2	
A3	17	PC3	AD3	
A4	18	PC4	AD4	SDA
A5	19	PC5	AD5	SCL

OTHER	CIRCUITPYTHON	GPIO	ARDUINO	NAME
SCK	D13	PB5	13	13
MISO	D12	PB4	12	12
MOSI / OC2A	D11	PB3	11	11
SS / OC1B	D10	PB2	10	10
OC1A	D9	PB1	9	9
	D8	PB0	8	8
	D7	PD7	7	7
OC0A	D6	PD6	6	6
OC0B	D5	PD5	5	5
	D4	PD4	4	4
INT1 / OC2B	D3	PD3	3	3
INT0	D2	PD2	2	2
TX	D1	PD1	1	1
RX	D0	PD0	0	0

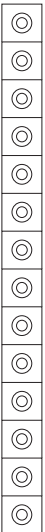

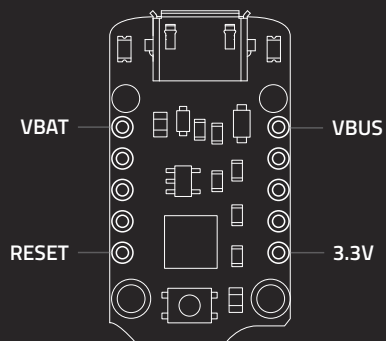



	NAME	GPIO	INT	PWM	ADC	SPECIAL
⊙	VBAT*					
⊙	GND					
⊙	4	PB4	PCINT4	OC1B	A2	USB
⊙	3	PB3	PCINT3	!OC1B	!A3	USB
⊙	RESET					

	NAME	GPIO	INT	PWM	SPI	ADC	SPECIAL
⊙	VBUS**						
⊙	0	PB0	PCINT0	OC0A / !OC1A	MOSI		
⊙	1	PB1	PCINT1	OC0B / OC1A	MISO		LED
⊙	2	PB2	INT0 / PCINT2		SCK	A1	
⊙	3.3V***						

\*VBAT 4.3-16V Battery \*\*VBUS +USB (+5V 500mA) \*\*\*+3.3V (150mA) regulated from BAT

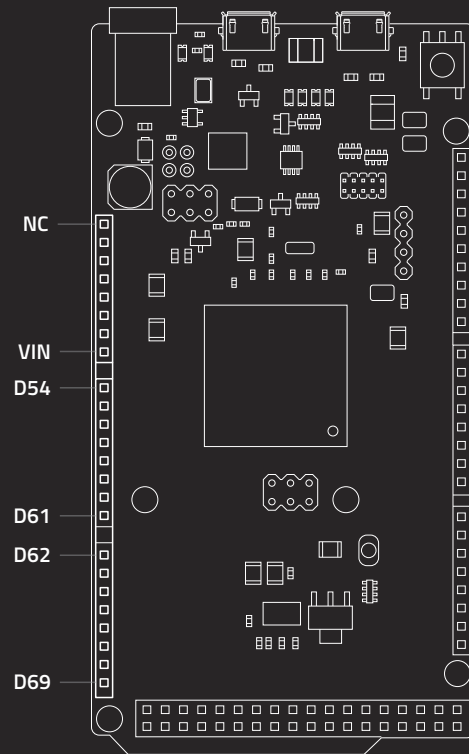

	NAME	MAIN FUNCTIONS	ANALOG	PWM	COMMS	CAN	TIMER	INTERRUPT
<input type="checkbox"/>	NC							
<input type="checkbox"/>	IOREF							
<input type="checkbox"/>	RESET							
<input type="checkbox"/>	3.3V							
<input type="checkbox"/>	5V							
<input type="checkbox"/>	GND							
<input type="checkbox"/>	GND							
<input type="checkbox"/>	VIN							
<input type="checkbox"/>	D54 / A0	PA16	ADC[0]	AD[7]	SPCK1			
<input type="checkbox"/>	D55 / A1	PA24	ADC[1]	AD[6]			PCK1	
<input type="checkbox"/>	D56 / A2	PA23	ADC[2]	AD[5]			TCLK4	
<input type="checkbox"/>	D57 / A3	PA22	ADC[3]	AD[4]			TCLK3	
<input type="checkbox"/>	D58 / A4	PA6	ADC[4]	AD[3]			TIOB2	
<input type="checkbox"/>	D59 / A5	PA4	ADC[5]	AD[2]			TCLK1	
<input type="checkbox"/>	D60 / A6	PA3	ADC[6]	AD[1]	PWMF1		TIOB1	WKUP[1]
<input type="checkbox"/>	D61 / A7	PA2	ADC[7]	AD[0]			TIOA1	
<input type="checkbox"/>	D62 / A8	PB17	ADC[8]	AD[10]	PWML1			
<input type="checkbox"/>	D63 / A9	PB18	ADC[9]	AD[11]	PWML2			
<input type="checkbox"/>	D64 / A10	PB19	ADC[10]	AD[12]	PWML3			
<input type="checkbox"/>	D65 / A11	PB20	ADC[11]	AD[13]		TXD2 / SPI0_NPCS1		
<input type="checkbox"/>	D66 / DAC2	PB15	DAC[0]	DAC[0]	PWMH3	CANRX1		WKUP[12]
<input type="checkbox"/>	D67 / DAC1	PB16	DAC[1]	DAC[1]	PWML0		TCLK5	
<input type="checkbox"/>	D68 / CANRX	PA1	CANRX0			CANRX0	PCK0	WKUP[0]
<input type="checkbox"/>	D69 / CANTX	PA0	CANTX0		PWML3	CANTX0		

Power: VIN 6-20V input to the board. Total DC output current per I/O lines is 130mA. Extra pinout functions are available in the official documentation.

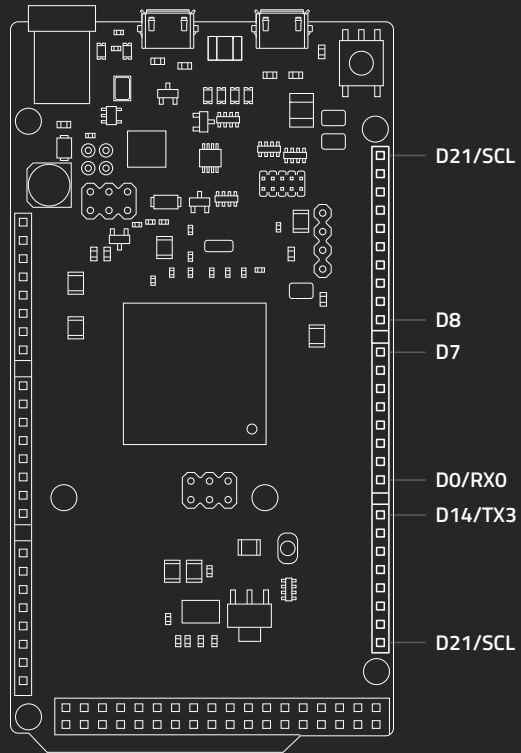

NAME	MAIN		ANALOG	PWM	COMM	TIMER	INTERRUPT
<input type="checkbox"/> D21 / SCL	PA18	SCL			TWCK0		WKUP[9]
<input type="checkbox"/> D20 / SDA	PA17	SDA			SPCK0/TWDO		
<input type="checkbox"/> AREF	AREF				AREF		
<input type="checkbox"/> GND							
<input type="checkbox"/> D13	PB27		AD[10]	PWML1			
<input type="checkbox"/> D12	PD8					TIOB8	
<input type="checkbox"/> D11	PD7					TIOA8	
<input type="checkbox"/> D10	PA28				SPI0_NPCS0	PCK2	WKUP[11]
<input type="checkbox"/> D9	PC21			PWML4			
<input type="checkbox"/> D8	PC22			PWML5			
<input type="checkbox"/> D7	PC23			PWML6			
<input type="checkbox"/> D6	PC24			PWML7			
<input type="checkbox"/> D5	PC25					TIOA6	
<input type="checkbox"/> D4	PA29				SPI0_NPCS1		
<input type="checkbox"/> D3	PC28					TIOA7	
<input type="checkbox"/> D2	PB25				RTS0	TIOA0	
<input type="checkbox"/> D1 / TX0	PA9			PWMH3	UTXD		
<input type="checkbox"/> D0 / RX0	PA8			PWMH0	URXD		WKUP[4]
<input type="checkbox"/> D14 / TX3	PD4				TXD3		
<input type="checkbox"/> D15 / RX3	PD5				RXD3		
<input type="checkbox"/> D16 / TX2	PA13			PWMH2	TXD1		
<input type="checkbox"/> D17 / TX2	PA12			PWML1	RXD1		WKUP[7]
<input type="checkbox"/> D18 / TX1	PA11				TXD0		ADTRG / WKUP[6]
<input type="checkbox"/> D19 / RX1	PA10				RXD0		DATR / WKUP[5]
<input type="checkbox"/> D20 / SDA	PB12		AD[8]	PWMH0	TWD1		
<input type="checkbox"/> D21 / SCL	PB13		AD[9]	PWMH1	TWCK1		

Power: VIN 6-20V input to the board. Total DC output current per I/O lines is 130mA. Extra pinout functions are available in the official documentation.

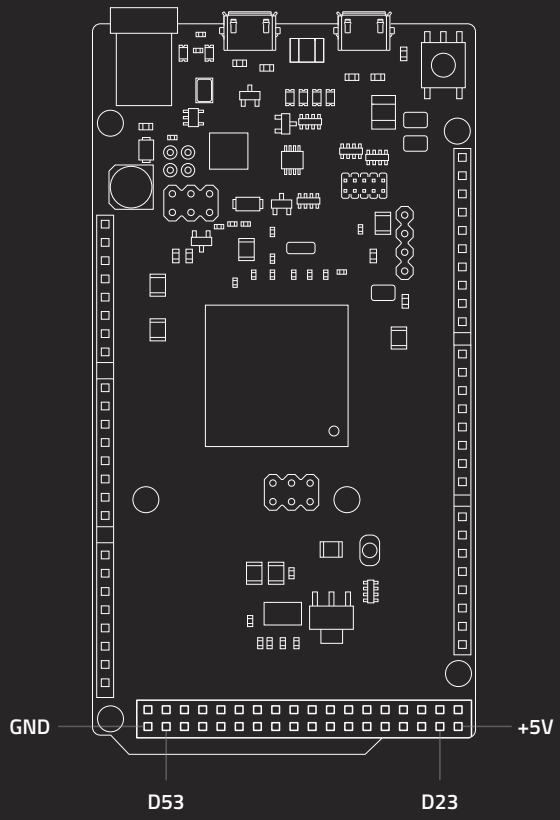



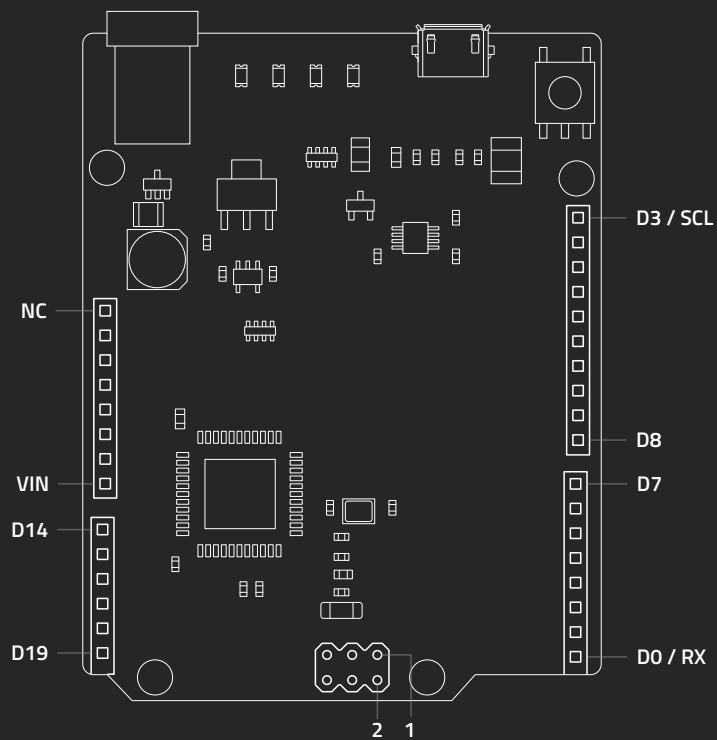



FUNCTIONS	
<input type="checkbox"/>	NC
<input type="checkbox"/>	IOREF
<input type="checkbox"/>	RESET
<input type="checkbox"/>	+3V3
<input type="checkbox"/>	+5V
<input type="checkbox"/>	GND
<input type="checkbox"/>	GND
<input type="checkbox"/>	VIN

<input type="checkbox"/>	D14 / A0	PF7	ADC[7]	TDI JTAG DATA INPUT
<input type="checkbox"/>	D15 / A1	PF6	ADC[6]	TDO JTAG DATA OUTPUT
<input type="checkbox"/>	D16 / A2	PF5	ADC[5]	TMS JTAG TEST MODE SLECT
<input type="checkbox"/>	D17 / A3	PF4	ADC[4]	TCK JTAG TEST CLOCK
<input type="checkbox"/>	D18 / A4	PF1	ADC[1]	
<input type="checkbox"/>	D19 / A5	PF0	ADC[0]	

FUNCTIONS						
			SCL	D3 / SCL	<input type="checkbox"/>	
			SDA	D2 / SDA	<input type="checkbox"/>	
			AREF	AREF	<input type="checkbox"/>	
				GND	<input type="checkbox"/>	
	CLK0/OC4A		PC7	D13	<input type="checkbox"/>	
	T1/OC4D		ADC[9]	PD6	D12	<input type="checkbox"/>
	OC1C/OC0A	RTS		PB7	D11	<input type="checkbox"/>
	OC4B/OC1B		ADC[13]	PB6	D10	<input type="checkbox"/>
	OC1A/OC4B		ADC[12]	PB5	D9	<input type="checkbox"/>
			ADC[11]	PB4	D8	<input type="checkbox"/>

			AIN[0]	PE6	D7	<input type="checkbox"/>
	T0/OC4D		ADC[10]	PD7	D6	<input type="checkbox"/>
	ICP3/OC3A/OC4A			PC6	D5	<input type="checkbox"/>
	ICP1		ADC[8]	PD4	D4	<input type="checkbox"/>
	OC0B	SCL		PD0	D3	<input type="checkbox"/>
		SDA		PD1	D2	<input type="checkbox"/>
		TXD1		PD3	D1 / TX	<input type="checkbox"/>
		RXD1		PD2	D0 / RX	<input type="checkbox"/>

FUNCTIONS					#
PCINT[3]	CIPO	PB3	CIPO		1
PCINT[1]	SCLK	PB1	SCK		3
			RESET		5



#	FUNCTIONS			
2	+5V			
4	COPI	PB2	COPI	PCINT[2]
6	GND			

Power: VIN is 6-20V input to the board. Maximum current per I/O pin is 20mA. Maximum current per +3.3V pin is 50mA.

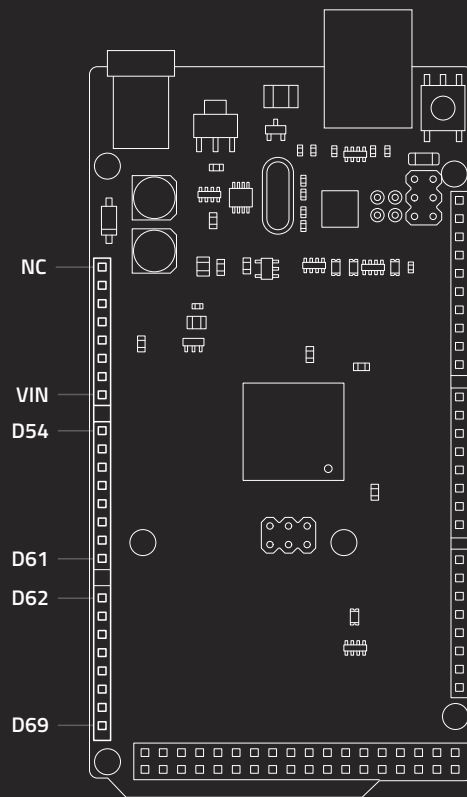

	NAME	FUNCTIONS			
<input type="checkbox"/>	NC				
<input type="checkbox"/>	IOREF				
<input type="checkbox"/>	RESET				
<input type="checkbox"/>	+3V3				
<input type="checkbox"/>	+5V				
<input type="checkbox"/>	GND				
<input type="checkbox"/>	GND				
<input type="checkbox"/>	VIN				
<input type="checkbox"/>	D54 / A0	PF0	ADC[0]		
<input type="checkbox"/>	D55 / A1	PF1	ADC[1]		
<input type="checkbox"/>	D56 / A2	PF2	ADC[2]		
<input type="checkbox"/>	D57 / A3	PF3	ADC[3]		
<input type="checkbox"/>	D58 / A4	PF4	ADC[4]	TCK JTAG TEST CLOCK	
<input type="checkbox"/>	D59 / A5	PF5	ADC[5]	TMS JTAG TEST MODE SLECT	
<input type="checkbox"/>	D60 / A6	PF6	ADC[6]	TDO JTAG DATA OUTPUT	
<input type="checkbox"/>	D61 / A7	PF7	ADC[7]	TDI JTAG DATA INPUT	
<input type="checkbox"/>	D62 / A8	PK0	ADC[8]		PCINT[16]
<input type="checkbox"/>	D63 / A9	PK1	ADC[9]		PCINT[17]
<input type="checkbox"/>	D64 / A10	PK2	ADC[10]		PCINT[18]
<input type="checkbox"/>	D65 / A11	PK3	ADC[11]		PCINT[19]
<input type="checkbox"/>	D66 / A12	PK4	ADC[12]		PCINT[20]
<input type="checkbox"/>	D67 / A13	PK5	ADC[13]		PCINT[21]
<input type="checkbox"/>	D68 / A14	PK6	ADC[14]		PCINT[22]
<input type="checkbox"/>	D69 / A15	PK7	ADC[15]		PCINT[23]

Power: VIN 6-20V input to the board. Maximum current per I/O pin is 20mA. Maximum current per +3.3V pin is 50mA. Extended pinout functions are available in the official documentation.

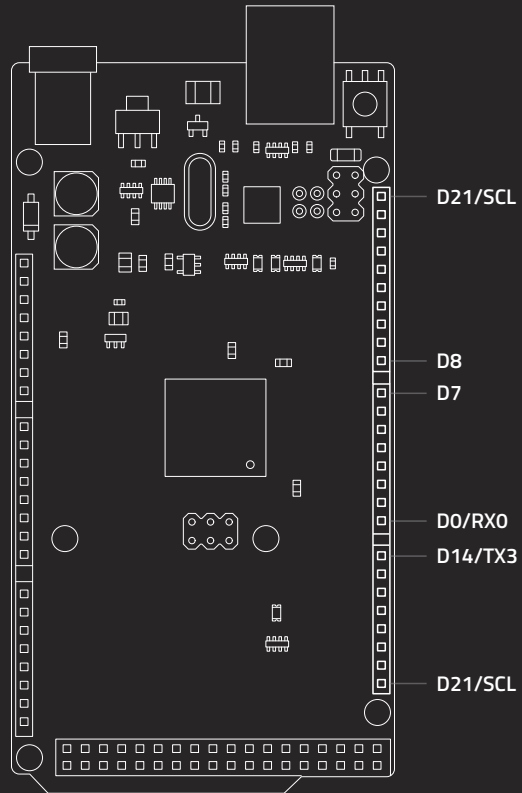

	NAME	FUNCTIONS				
<input type="checkbox"/>	D21 / SCL	PD0		SCL		INT[0]
<input type="checkbox"/>	D20 / SDA	PD1		SDA		INT[1]
<input type="checkbox"/>	AREF	AREF				
<input type="checkbox"/>	GND					
<input type="checkbox"/>	D13	PB7			OC0A/OC1C	PCINT[7]
<input type="checkbox"/>	D12	PB6			OC1B	PCINT[6]
<input type="checkbox"/>	D11	PB5			OC1A	PCINT[5]
<input type="checkbox"/>	D10	PB4			OC2A	PCINT[4]
<input type="checkbox"/>	D9	PH6			OC2B	
<input type="checkbox"/>	D8	PH5			OC4C	
<input type="checkbox"/>	D7	PH4			OC4B	
<input type="checkbox"/>	D6	PH3			OC4A	
<input type="checkbox"/>	D5	PE3	AIN[1]		OC3A	
<input type="checkbox"/>	D4	PG5			OC0B	
<input type="checkbox"/>	D3	PE5			OC3C	INT[5]
<input type="checkbox"/>	D2	PE4			OC3B	INT[4]
<input type="checkbox"/>	D1 / TX0	PE1		TXD0		
<input type="checkbox"/>	D0 / RX0	PE0		RXD0		PCINT[8]
<input type="checkbox"/>	D14 / TX3	PJ1		TXD3		PCINT[10]
<input type="checkbox"/>	D15 / RX3	PJ0		RXD3		PCINT[9]
<input type="checkbox"/>	D16 / TX2	PH1		TXD2		
<input type="checkbox"/>	D17 / TX2	PH0		RXD3		
<input type="checkbox"/>	D18 / TX1	PD3		TXD1		INT[3]
<input type="checkbox"/>	D19 / RX1	PD2		RXD1		INT[2]
<input type="checkbox"/>	D20 / SDA	PD1		SDA		INT[1]
<input type="checkbox"/>	D21 / SCL	PD0		SCL		INT[0]

Power: VIN 6-20V input to the board. Maximum current per I/O pin is 20mA. Maximum current per +3.3V pin is 50mA. Extended pinout functions are available in the official documentation.

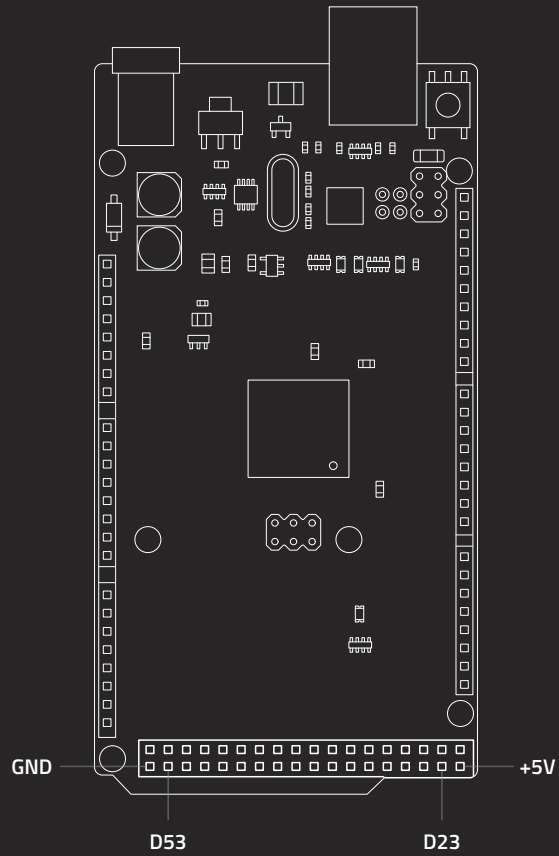



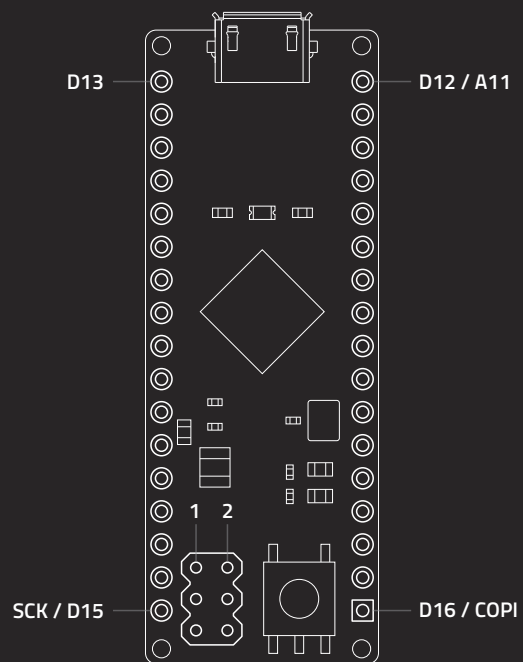



	NAME	FUNCTIONS			FUNCTIONS		NAME	
○	D13	PC7			PD6	A11 / D12		○
○	+3V3				PB7	D11		○
○	AREF	AREF			PB6	A10 / D10		○
○	A0 / D18	PF7	ADC[7]		PB5	A9 / D9		○
○	A1 / D19	PF6	ADC[6]		PB4	A8 / D8		○
○	A2 / D20	PF5	ADC[5]		PE6	D7		○
○	A3 / D21	PF4	ADC[4]		PD7	A7 / D6		○
○	A4 / D22	PF1	ADC[1]		PC6	D5		○
○	A5 / D23	PF0	ADC[0]		PD4	A6 / D4		○
○	NC				PD0	SCL / D3		○
○	NC				PD1	SDA / D2		○
○	+5V					GND		○
○	RESET					RESET		○
○	GND				PD2	RX / D0		○
○	VIN				PD3	TX / D1		○
○	CIPO / D14	PB3	CIPO		SS	PB0	SS / D17	○
○	SCK / D15	PB1	SCK		COPI	PB2	COPI / D16	□

FUNCTIONS				#
PCINT[3]	CIPO	PB3	CIPO	1
PCINT[1]	SCLK	PB1	SCK	3
			RESET	5



#	FUNCTIONS			
2	+5V			
4	COPI	PB2	COPI	PCINT[2]
6	GND			

Power: VIN 6-9V input to the board. Maximum current per I/O pin is 40mA. Maximum current per +3.3V pin is 50mA

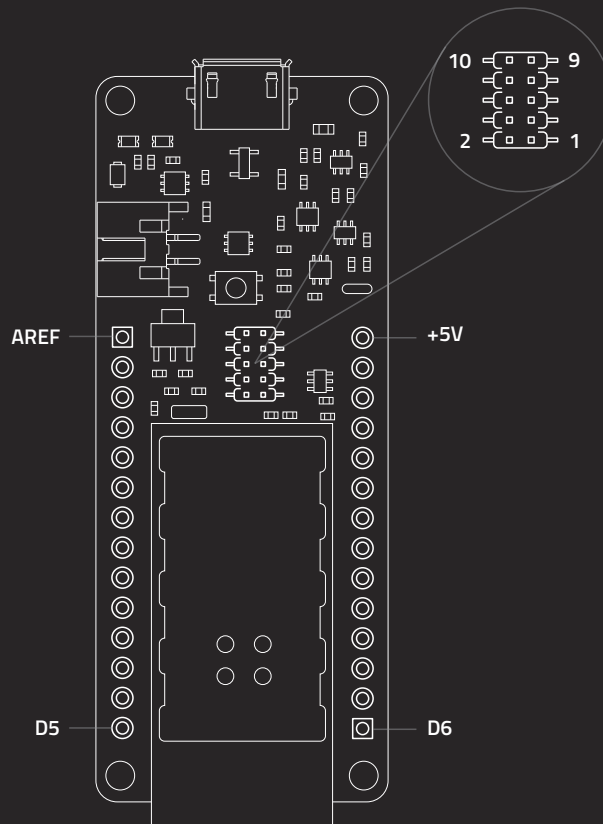

	NAME	FUNCTIONS		
<input type="checkbox"/>	AREF	PA03	AREF / AIN[1]	
<input type="radio"/>	D15 / A0	PA02	DAC0 / AIN[0]	+5V <input type="radio"/>
<input type="radio"/>	D16 / A1	PB02	AIN[10]	VIN <input type="radio"/>
<input type="radio"/>	D17 / A2	PB03	AIN[11]	+3V3 <input type="radio"/>
<input type="radio"/>	D18 / A3	PA04	AIN[4]	GND <input type="radio"/>
<input type="radio"/>	D19 / A4	PA05	AIN[5]	RESET <input type="radio"/>
<input type="radio"/>	D20 / A5	PA06	AIN[6]	TX (SC5) PB22 D14 <input type="radio"/>
<input type="radio"/>	D21 / A6	PA07	AIN[7]	RX (SC5) PB23 D13 <input type="radio"/>
<input type="radio"/>	D0	PA22		SCL (SC2) PA09 D12 <input type="radio"/>
<input type="radio"/>	D1	PA23		SDA (SC2) PA08 D11 <input type="radio"/>
<input type="radio"/>	D2	PA10		CIPO (SC1) PA19 D10 <input type="radio"/>
<input type="radio"/>	D3	PA11		SCK (SC1) PA17 D9 <input type="radio"/>
<input type="radio"/>	D4	PB10		COPI (SC1) PA16 D8 <input type="radio"/>
<input type="radio"/>	D5	PB11		PA21 D7 <input type="radio"/>
<input type="checkbox"/>				PA20 D6 <input type="checkbox"/>

FUNCTIONS			#		#	FUNCTIONS
RESET_N			10		9	GND
			8		7	
			6		5	GND
TCC1 / WO[0]	PA30	SWCLK	4		3	GND
TCC1 / WO[1]	PA31	SWDIO	2		1	+3V3

Power: Maximum current per pin is 7mA. Maximum source current is 46mA. Maximum sink current is 65mA per pin group. Further pinout functions are also available in official datasheet.

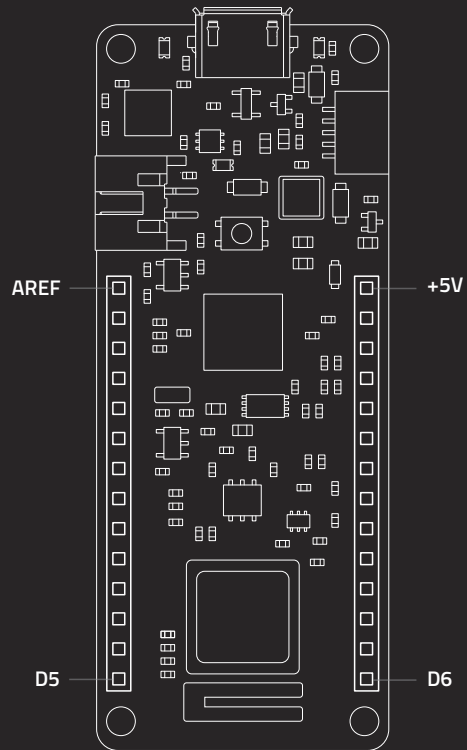

	NAME	FUNCTIONS			FUNCTIONS	NAME	
<input checked="" type="checkbox"/>	AREF	PA03	AREF / AIN[1]			+5V	<input type="checkbox"/>
<input type="checkbox"/>	D15 / A0	PA02	DAC0 / AIN[0]			VIN	<input type="checkbox"/>
<input type="checkbox"/>	D16 / A1	PB02	AIN[10]			+3V3	<input type="checkbox"/>
<input type="checkbox"/>	D17 / A2	PB03	AIN[11]			GND	<input type="checkbox"/>
<input type="checkbox"/>	D18 / A3	PA04	AIN[4]			RESET	<input type="checkbox"/>
<input type="checkbox"/>	D19 / A4	PA05	AIN[5]		TX (SC5) PB22	D14	<input type="checkbox"/>
<input type="checkbox"/>	D20 / A5	PA06	AIN[6]		RX (SC5) PB23	D13	<input type="checkbox"/>
<input type="checkbox"/>	D21 / A6	PA07	AIN[7]		SCL (SC2) PA09	D12	<input type="checkbox"/>
<input type="checkbox"/>	D0	PA22			SDA (SC2) PA08	D11	<input type="checkbox"/>
<input type="checkbox"/>	D1	PA23			CIPO (SC1) PA19	D10	<input type="checkbox"/>
<input type="checkbox"/>	D2	PA10			SCK (SC1) PA17	D9	<input type="checkbox"/>
<input type="checkbox"/>	D3	PA11			COPI (SC1) PA16	D8	<input type="checkbox"/>
<input type="checkbox"/>	D4	PB10			PA21	D7	<input type="checkbox"/>
<input type="checkbox"/>	D5	PB11			PA20	D6	<input checked="" type="checkbox"/>

Power: Maximum current per pin is 7mA. Maximum source current is 46mA. Maximum sink current is 65mA per pin group. Further pinout functions are also available in official datasheet.

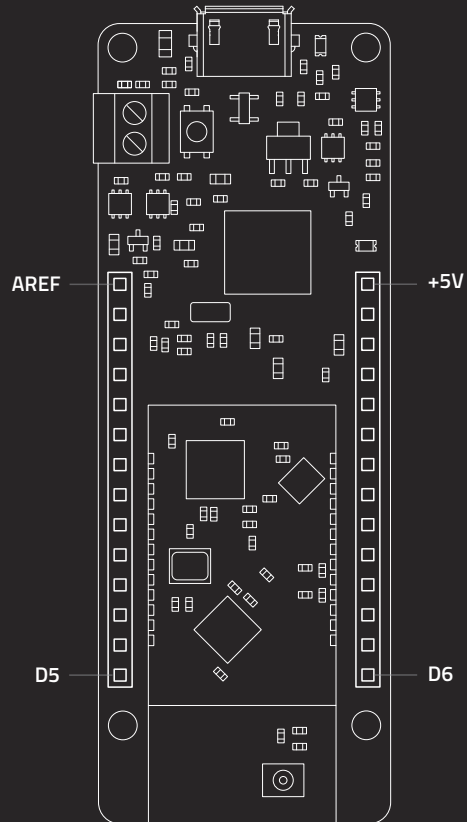

	NAME	FUNCTIONS		FUNCTIONS		NAME	
⊠	AREF	PA03	AREF / AIN[1]			+5V	○
○	D15 / A0	PA02	DAC0 / AIN[0]			VIN	○
○	D16 / A1	PB02	AIN[10]			+3V3	○
○	D17 / A2	PB03	AIN[11]			GND	○
○	D18 / A3	PA04	AIN[4]			RESET	○
○	D19 / A4	PA05	AIN[5]	TX (SC5)	PB22	D14	○
○	D20 / A5	PA06	AIN[6]	RX (SC5)	PB23	D13	○
○	D21 / A6	PA07	AIN[7]	SCL (SC2)	PA09	D12	○
○	D0	PA22		SDA (SC2)	PA08	D11	○
○	D1	PA23		CIPO (SC1)	PA19	D10	○
○	D2	PA10		SCK (SC1)	PA17	D9	○
○	D3	PA11		COPI (SC1)	PA16	D8	○
○	D4	PB10			PA21	D7	○
○	D5	PB11			PA20	D6	⊠

Power: Maximum current per pin is 7mA. Maximum source current is 46mA. Maximum sink current is 65mA per pin group. Further pinout functions are also available in official datasheet.

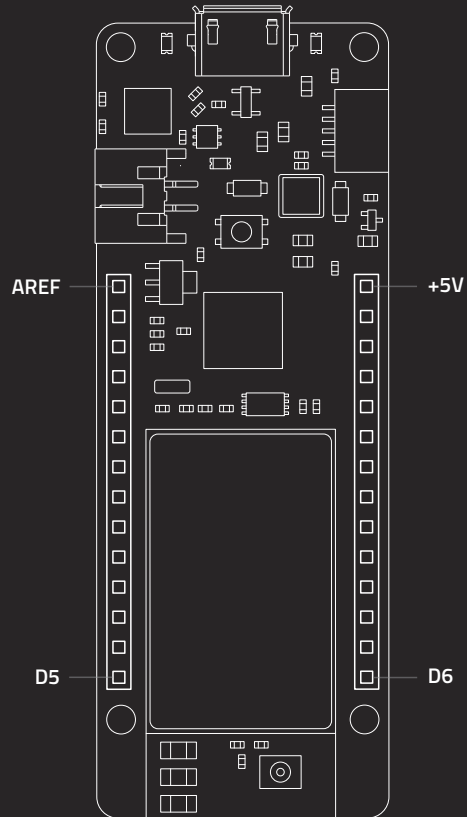



	NAME	FUNCTIONS			FUNCTIONS	NAME		
<input checked="" type="checkbox"/>	AREF	PA03	AREF / AIN[1]			+5V	<input type="checkbox"/>	
<input type="checkbox"/>	D15 / A0	PA02	DAC0 / AIN[0]			VIN	<input type="checkbox"/>	
<input type="checkbox"/>	D16 / A1	PB02	AIN[10]			+3V3	<input type="checkbox"/>	
<input type="checkbox"/>	D17 / A2	PB03	AIN[11]			GND	<input type="checkbox"/>	
<input type="checkbox"/>	D18 / A3	PA04	AIN[4]			RESET	<input type="checkbox"/>	
<input type="checkbox"/>	D19 / A4	PA05	AIN[5]		TX (SC5)	PB22	D14	<input type="checkbox"/>
<input type="checkbox"/>	D20 / A5	PA06	AIN[6]		RX (SC5)	PB23	D13	<input type="checkbox"/>
<input type="checkbox"/>	D21 / A6	PA07	AIN[7]		SCL (SC2)	PA09	D12	<input type="checkbox"/>
<input type="checkbox"/>	D0	PA22			SDA (SC2)	PA08	D11	<input type="checkbox"/>
<input type="checkbox"/>	D1	PA23			CIPO (SC1)	PA19	D10	<input type="checkbox"/>
<input type="checkbox"/>	D2	PA10			SCK (SC1)	PA17	D9	<input type="checkbox"/>
<input type="checkbox"/>	D3	PA11			COPI (SC1)	PA16	D8	<input type="checkbox"/>
<input type="checkbox"/>	D4	PB10				PA21	D7	<input type="checkbox"/>
<input type="checkbox"/>	D5	PB11				PA20	D6	<input checked="" type="checkbox"/>

Power: Maximum current per pin is 7mA. Maximum source current is 46mA. Maximum sink current is 65mA per pin group. Further pinout functions are also available in official datasheet.

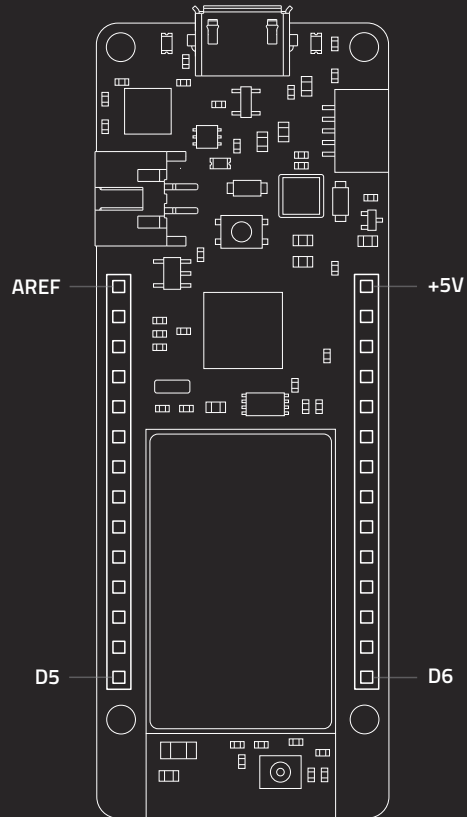

	NAME	FUNCTIONS		FUNCTIONS			NAME	
<input checked="" type="checkbox"/>	AREF	PA03	AREF / AIN[1]			+5V		<input type="checkbox"/>
<input type="checkbox"/>	D15 / A0	PA02	DAC0 / AIN[0]			VIN		<input type="checkbox"/>
<input type="checkbox"/>	D16 / A1	PB02	AIN[10]			+3V3		<input type="checkbox"/>
<input type="checkbox"/>	D17 / A2	PB03	AIN[11]			GND		<input type="checkbox"/>
<input type="checkbox"/>	D18 / A3	PA04	AIN[4]			RESET		<input type="checkbox"/>
<input type="checkbox"/>	D19 / A4	PA05	AIN[5]	TX (SC5)	PB22	D14		<input type="checkbox"/>
<input type="checkbox"/>	D20 / A5	PA06	AIN[6]	RX (SC5)	PB23	D13		<input type="checkbox"/>
<input type="checkbox"/>	D21 / A6	PA07	AIN[7]	SCL (SC2)	PA09	D12		<input type="checkbox"/>
<input type="checkbox"/>	D0	PA22		SDA (SC2)	PA08	D11		<input type="checkbox"/>
<input type="checkbox"/>	D1	PA23		CIPO (SC1)	PA19	D10		<input type="checkbox"/>
<input type="checkbox"/>	D2	PA10		SCK (SC1)	PA17	D9		<input type="checkbox"/>
<input type="checkbox"/>	D3	PA11		COPI (SC1)	PA16	D8		<input type="checkbox"/>
<input type="checkbox"/>	D4	PB10			PA21	D7		<input type="checkbox"/>
<input type="checkbox"/>	D5	PB11			PA20	D6		<input checked="" type="checkbox"/>

Power: Maximum current per pin is 7mA. Maximum source current is 46mA. Maximum sink current is 65mA per pin group. Further pinout functions are also available in official datasheet.

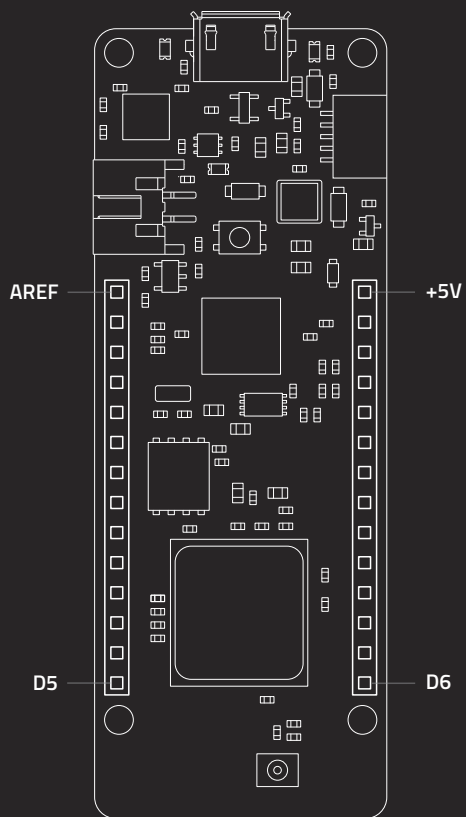

	NAME	FUNCTIONS		FUNCTIONS		NAME	
<input checked="" type="checkbox"/>	AREF	PA03	AREF / AIN[1]			+5V	<input type="checkbox"/>
<input type="checkbox"/>	D15 / A0	PA02	DAC0 / AIN[0]			VIN	<input type="checkbox"/>
<input type="checkbox"/>	D16 / A1	PB02	AIN[10]			+3V3	<input type="checkbox"/>
<input type="checkbox"/>	D17 / A2	PB03	AIN[11]			GND	<input type="checkbox"/>
<input type="checkbox"/>	D18 / A3	PA04	AIN[4]			RESET	<input type="checkbox"/>
<input type="checkbox"/>	D19 / A4	PA05	AIN[5]	TX (SC5)	PB22	D14	<input type="checkbox"/>
<input type="checkbox"/>	D20 / A5	PA06	AIN[6]	RX (SC5)	PB23	D13	<input type="checkbox"/>
<input type="checkbox"/>	D21 / A6	PA07	AIN[7]	SCL (SC2)	PA09	D12	<input type="checkbox"/>
<input type="checkbox"/>	D0	PA22		SDA (SC2)	PA08	D11	<input type="checkbox"/>
<input type="checkbox"/>	D1	PA23		CIPO (SC1)	PA19	D10	<input type="checkbox"/>
<input type="checkbox"/>	D2	PA10		SCK (SC1)	PA17	D9	<input type="checkbox"/>
<input type="checkbox"/>	D3	PA11		COPI (SC1)	PA16	D8	<input type="checkbox"/>
<input type="checkbox"/>	D4	PB10			PA21	D7	<input type="checkbox"/>
<input type="checkbox"/>	D5	PB11			PA20	D6	<input checked="" type="checkbox"/>

Power: Maximum current per pin is 7mA. Maximum source current is 46mA. Maximum sink current is 65mA per pin group. Further pinout functions are also available in official datasheet.

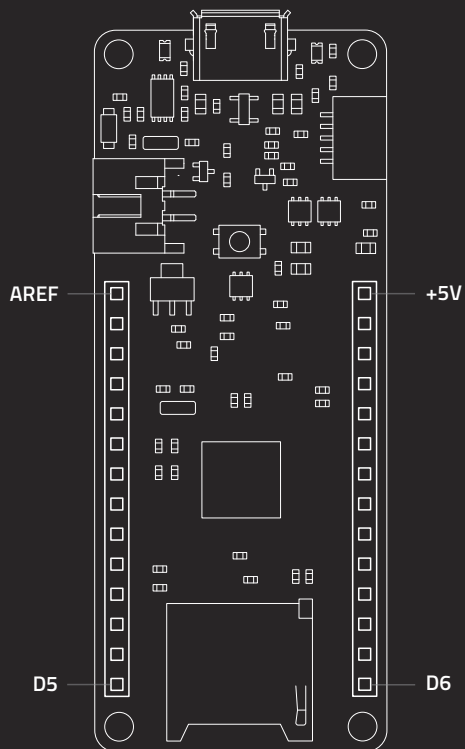

	NAME	FUNCTIONS		FUNCTIONS		NAME	
<input checked="" type="checkbox"/>	AREF	PA03	AREF / AIN[1]			+5V	<input type="checkbox"/>
<input type="checkbox"/>	D15 / A0	PA02	DAC0 / AIN[0]			VIN	<input type="checkbox"/>
<input type="checkbox"/>	D16 / A1	PB02	AIN[10]			+3V3	<input type="checkbox"/>
<input type="checkbox"/>	D17 / A2	PB03	AIN[11]			GND	<input type="checkbox"/>
<input type="checkbox"/>	D18 / A3	PA04	AIN[4]			RESET	<input type="checkbox"/>
<input type="checkbox"/>	D19 / A4	PA05	AIN[5]	TX (SC5)	PB22	D14	<input type="checkbox"/>
<input type="checkbox"/>	D20 / A5	PA06	AIN[6]	RX (SC5)	PB23	D13	<input type="checkbox"/>
<input type="checkbox"/>	D21 / A6	PA07	AIN[7]	SCL (SC2)	PA09	D12	<input type="checkbox"/>
<input type="checkbox"/>	D0	PA22		SDA (SC2)	PA08	D11	<input type="checkbox"/>
<input type="checkbox"/>	D1	PA23		CIPO (SC1)	PA19	D10	<input type="checkbox"/>
<input type="checkbox"/>	D2	PA10		SCK (SC1)	PA17	D9	<input type="checkbox"/>
<input type="checkbox"/>	D3	PA11		COPI (SC1)	PA16	D8	<input type="checkbox"/>
<input type="checkbox"/>	D4	PB10			PA21	D7	<input type="checkbox"/>
<input type="checkbox"/>	D5	PB11			PA20	D6	<input checked="" type="checkbox"/>

Power: Maximum current per pin is 7mA. Maximum source current is 46mA. Maximum sink current is 65mA per pin group. Further pinout functions are also available in official datasheet.

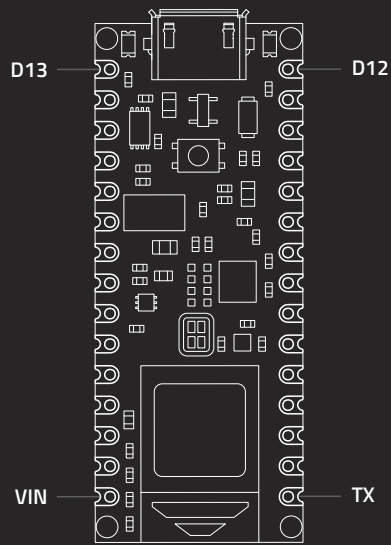



NAME	FUNCTIONS		FUNCTIONS		NAME
D13	P0.13	SCK	CIPO	P1.08	D12
+3V3			COPI	P1.01	D11
AREF				P1.02	D10
A0	P0.04			P0.27	D9
A1	P0.05			P0.21	D8
A2	P0.30			P0.23	D7
A3	P0.29			P1.14	D6
A4	P0.31	SDA		P1.13	D5
A5	P0.02	SCL		P1.15	D4
A6	P0.28			P1.12	D3
A7	P0.03			P1.11	D2
+5V					GND
RESET					RESET
GND				P1.10	RX
VIN				P1.03	TX

*Power: 5-21V input to the board. Maximum output current per pin is 15mA. Maximum input current per pin is 5mA. Maximum external current is 25mA for the sum of all GPIO current and the current being drawn from VDD. Extra pin functions are listed in the official datasheet.*

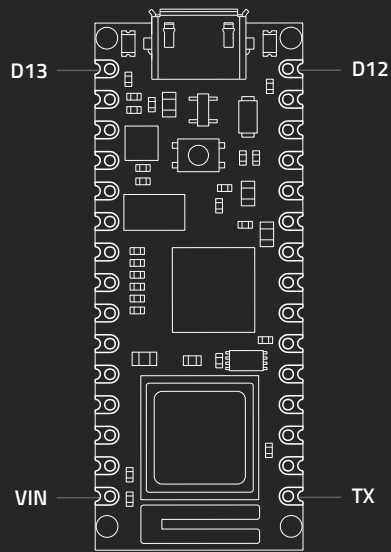

NAME	FUNCTIONS		FUNCTIONS		NAME
D13	PA17	SCK (SC1)	CIPO (SC1)	PA19	D12
+3V3			COPI (SC1)	PA16	D11
AREF	PA03			PA21	D10
D14 / A0	PA02	DACO / AIN[0]		PA20	D9
D15 / A1	PB02	AIN[10]		PA18	D8
D16 / A2	PA11	AIN[19]		PA06	D7
D17 / A3	PA10	AIN[18]		PA04	D6
D18 / A4	PB08	SDA (SC4)		PA05	D5
D19 / A5	PB09	SCL (SC4)		PA07	D4
D20 / A6	PA09	AIN[17]		PB11	D3
D21 / A7	PB03	AIN[11]		PB10	D2
+5V					GND
RESET					RESET
GND				PB23	RX
VIN				PB22	TX

Power: 5-21V input to the board. Maximum current per pin is 7mA. Maximum source current is 46mA. Maximum sink current is 65mA per pin group. Extra pin functions are listed in the official datasheet.

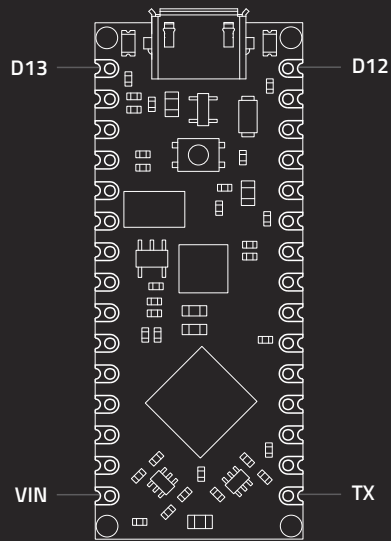

NAME	FUNCTIONS		FUNCTIONS		NAME
D13	PE2	SCK	CIPO (SC1)	PE1	D12
+3V3			COPI (SC1)	PE0	D11
AREF	PD7			PB1	D10
D14 / A0	PD3	AIN[3]		PB0	D9
D15 / A1	PD2	AIN[2]		PE3	D8
D16 / A2	PD1	AIN[1]		PA1	D7
D17 / A3	PD0	AIN[0]		PF4	D6
D18 / A4	PA2	SDA		PB2	D5
D19 / A5	PA3	SCL		PC6	D4
D20 / A6	PD4	AIN[4]		PF5	D3
D21 / A7	PD5	AIN[5]		PA0	D2
+5V					GND
RESET					RESET
GND				PC5	RX
VIN				PC5	TX

Power: 7-21V input to the board. Maximum current per pin 40mA, 20mA recommended. Maximum current 200mA for the entire package. The total current of each port power group should not exceed 100mA. Extra pin functions are listed in the official datasheet.

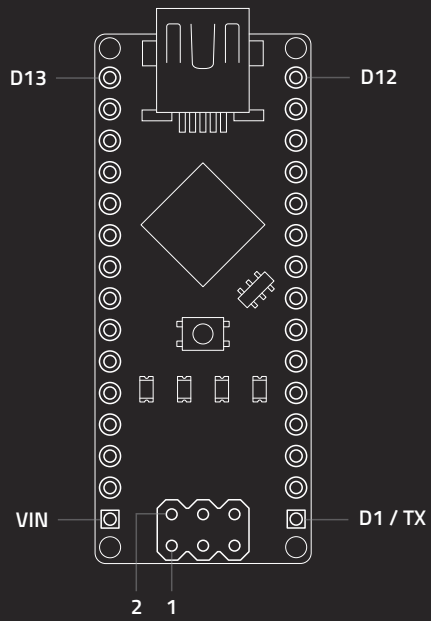

NAME	FUNCTIONS		FUNCTIONS	NAME	
D13	PB5		CIPO	PB4	D12
+3V3			COPI	PB3	D11
AREF				PB2	D10
D14 / A0	PC0	ADC[0]		PB1	D9
D15 / A1	PC1	ADC[1]		PB0	D8
D16 / A2	PC2	ADC[2]		PD7	D7
D17 / A3	PC3	ADC[3]		PD6	D6
D18 / A4	PC4	ADC[4]		PD5	D5
D19 / A5	PC5	ADC[5]		PD4	D4
A6	ADC[6]	ADC[6]		PD3	D3
A7	ADC[7]	ADC[7]		PD2	D2
+5V					GND
RESET	PC6			PC6	RESET
GND				PD0	RX
VIN				PD1	TX

FUNCTIONS				#
PCINT[4]	CIPO	PB4	CIPO	1
PCINT[5]	SCK	PB5	SCK	3
			RESET	5



#	FUNCTIONS			
2	+5V			
4	COPI	PB3	COPI	PCINT[3]
6	GND			

Power: 7-12V input to the board. Maximum current per I/O pin is 20mA. Maximum current per +3.3V pin is 50mA. Extra pin functions are listed in the official datasheet.

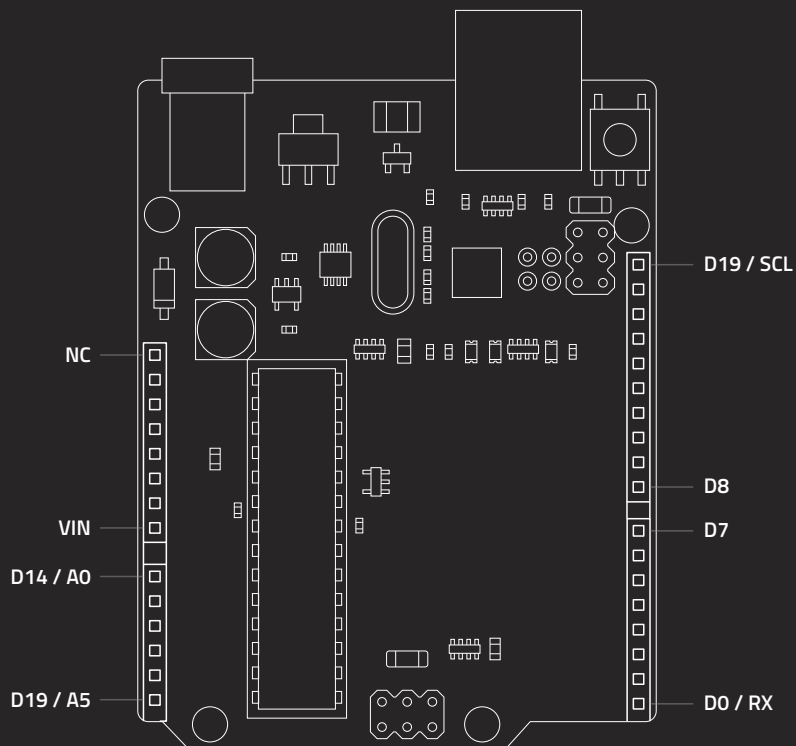



<input type="checkbox"/>	<b>FUNCTIONS</b>			<b>FUNCTIONS</b>			<input type="checkbox"/>
<input type="checkbox"/>	NC			SCL	PC5	D19 / SCL	<input type="checkbox"/>
<input type="checkbox"/>	IOREF			SDA	PC4	D18 / SDA	<input type="checkbox"/>
<input type="checkbox"/>	RESET	PC6				AREF	<input type="checkbox"/>
<input type="checkbox"/>	+3V3					GND	<input type="checkbox"/>
<input type="checkbox"/>	+5V			SCK	PB5	D13	<input type="checkbox"/>
<input type="checkbox"/>	GND			CIPO	PB4	D12	<input type="checkbox"/>
<input type="checkbox"/>	GND			COPI	PB3	D11	<input type="checkbox"/>
<input type="checkbox"/>	VIN			SS	PB2	D10	<input type="checkbox"/>
<input type="checkbox"/>					PB1	D9	<input type="checkbox"/>
<input type="checkbox"/>					PB0	D8	<input type="checkbox"/>
<input type="checkbox"/>							<input type="checkbox"/>
<input type="checkbox"/>	D14 / A0	PC0	ADC[0]		PD7	D7	<input type="checkbox"/>
<input type="checkbox"/>	D15 / A1	PC1	ADC[1]		PD6	D6	<input type="checkbox"/>
<input type="checkbox"/>	D16 / A2	PC2	ADC[2]		PD5	D5	<input type="checkbox"/>
<input type="checkbox"/>	D17 / A3	PC4	ADC[3]		PD4	D4	<input type="checkbox"/>
<input type="checkbox"/>	D18 / A4	PC4	ADC[4]		PD3	D3	<input type="checkbox"/>
<input type="checkbox"/>	D19 / A5	PC5	ADC[5]		PD2	D2	<input type="checkbox"/>
<input type="checkbox"/>					PD1	D1 / TX	<input type="checkbox"/>
<input type="checkbox"/>					PD0	D0 / RX	<input type="checkbox"/>

Power: 6-20V input to the board. Maximum current per I/O pin is 20mA. Maximum current per +3.3V pin is 50mA. Extra pin functions are listed in the official datasheet.

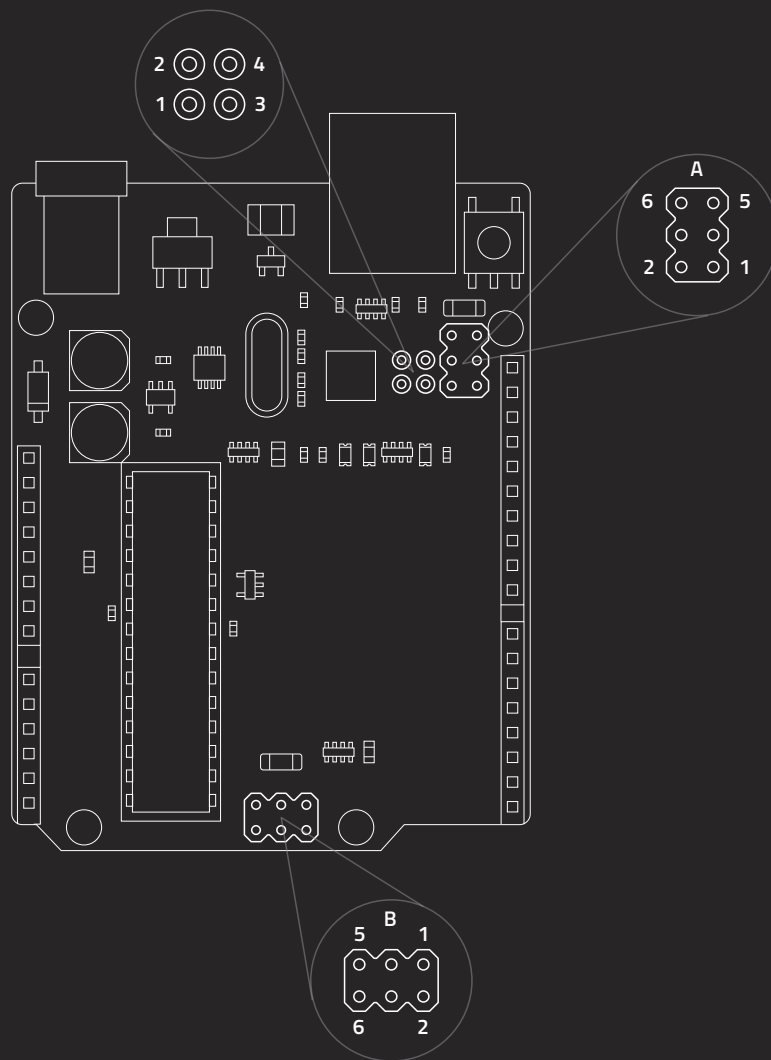

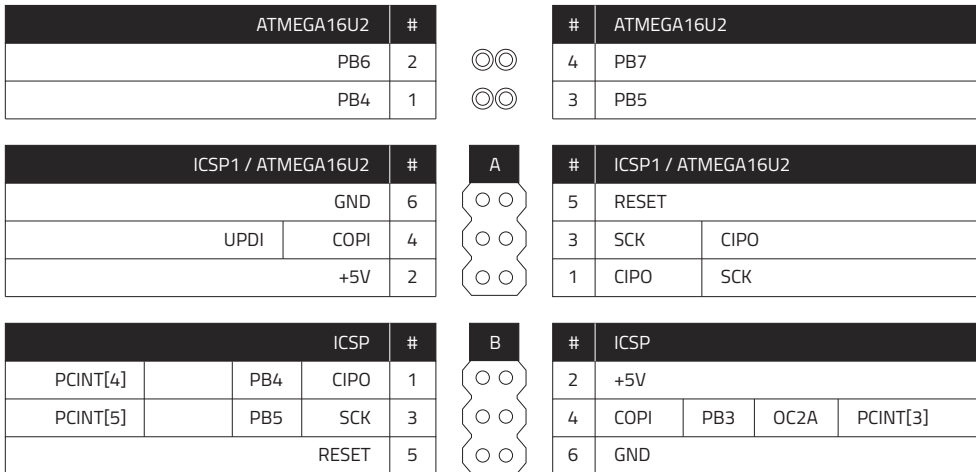

Power: 6-20V input to the board. Maximum current per I/O pin is 20mA. Maximum current per +3.3V pin is 50mA. Extra pin functions are listed in the official datasheet.

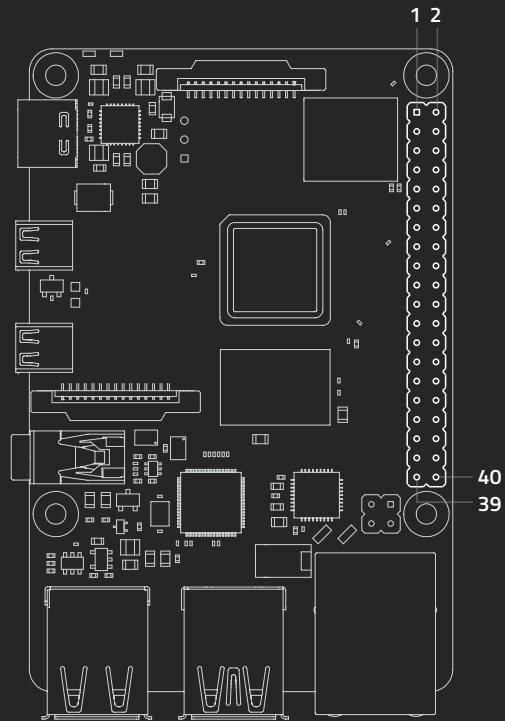

WIRING PI #	MAIN FUNCTIONS	#			#	MAIN FUNCTIONS	WIRING PI #
	3V3 POWER	1	<input type="checkbox"/>	<input type="radio"/>	2	5V POWER	
8	GPIO 2 (I2C1 SDA)	3	<input type="radio"/>	<input type="radio"/>	4	5V POWER	
9	GPIO 3 (I2C1 SCL)	5	<input type="radio"/>	<input type="radio"/>	6	GROUND	
7	GPIO 4 (GPCLK0)	7	<input type="radio"/>	<input type="radio"/>	8	GPIO 14 (UART TX)	15
	GROUND	9	<input type="radio"/>	<input type="radio"/>	10	GPIO 15 (UART RX)	16
0	GPIO 17	11	<input type="radio"/>	<input type="radio"/>	12	GPIO 18 (PCM CLK)	1
2	GPIO 27	13	<input type="radio"/>	<input type="radio"/>	14	GROUND	
3	GPIO 22	15	<input type="radio"/>	<input type="radio"/>	16	GPIO 23	4
	3V3 POWER	17	<input type="radio"/>	<input type="radio"/>	18	GPIO 24	5
12	GPIO 10 (SPI0 MOSI)	19	<input type="radio"/>	<input type="radio"/>	20	GROUND	
13	GPIO 9 (SPI0 MISO)	21	<input type="radio"/>	<input type="radio"/>	22	GPIO 25	6
14	GPIO 11 (SPI0 SCLK)	23	<input type="radio"/>	<input type="radio"/>	24	GPIO 8 (SPI0 CE0)	10
	GROUND	25	<input type="radio"/>	<input type="radio"/>	26	GPIO 7 (SPI0 CE1)	11
30	GPIO 0 (EEPROM SDA)	27	<input type="radio"/>	<input type="radio"/>	28	GPIO 1 (EEPROM SCL)	31
21	BCM 5	29	<input type="radio"/>	<input type="radio"/>	30	GROUND	
22	BCM 6	31	<input type="radio"/>	<input type="radio"/>	32	GPIO 12 (PWM0)	26
23	GPIO 13 (PWM1)	33	<input type="radio"/>	<input type="radio"/>	34	GROUND	
24	GPIO 19 (PCM FS)	35	<input type="radio"/>	<input type="radio"/>	36	GPIO 16	27
25	GPIO 26	37	<input type="radio"/>	<input type="radio"/>	38	GPIO 20 (PCM DIN)	28
	GROUND	39	<input type="radio"/>	<input type="radio"/>	40	GPIO 21 (PCM DOUT)	29

NOTE: Alternate pin functions are also available. Check the datasheet for more information.

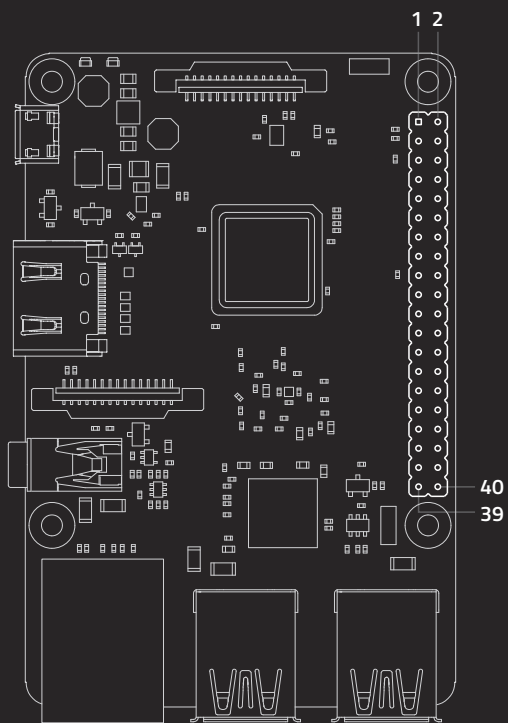

WIRING PI #	MAIN FUNCTIONS	#			#	MAIN FUNCTIONS	WIRING PI #
	3V3 POWER	1	<input type="checkbox"/>	<input type="radio"/>	2	5V POWER	
8	GPIO 2 (I2C1 SDA)	3	<input type="radio"/>	<input type="radio"/>	4	5V POWER	
9	GPIO 3 (I2C1 SCL)	5	<input type="radio"/>	<input type="radio"/>	6	GROUND	
7	GPIO 4 (GPCLK0)	7	<input type="radio"/>	<input type="radio"/>	8	GPIO 14 (UART TX)	15
	GROUND	9	<input type="radio"/>	<input type="radio"/>	10	GPIO 15 (UART RX)	16
0	GPIO 17	11	<input type="radio"/>	<input type="radio"/>	12	GPIO 18 (PCM CLK)	1
2	GPIO 27	13	<input type="radio"/>	<input type="radio"/>	14	GROUND	
3	GPIO 22	15	<input type="radio"/>	<input type="radio"/>	16	GPIO 23	4
	3V3 POWER	17	<input type="radio"/>	<input type="radio"/>	18	GPIO 24	5
12	GPIO 10 (SPI0 MOSI)	19	<input type="radio"/>	<input type="radio"/>	20	GROUND	
13	GPIO 9 (SPI0 MISO)	21	<input type="radio"/>	<input type="radio"/>	22	GPIO 25	6
14	GPIO 11 (SPI0 SCLK)	23	<input type="radio"/>	<input type="radio"/>	24	GPIO 8 (SPI0 CE0)	10
	GROUND	25	<input type="radio"/>	<input type="radio"/>	26	GPIO 7 (SPI0 CE1)	11
30	GPIO 0 (EEPROM SDA)	27	<input type="radio"/>	<input type="radio"/>	28	GPIO 1 (EEPROM SCL)	31
21	BCM 5	29	<input type="radio"/>	<input type="radio"/>	30	GROUND	
22	BCM 6	31	<input type="radio"/>	<input type="radio"/>	32	GPIO 12 (PWM0)	26
23	GPIO 13 (PWM1)	33	<input type="radio"/>	<input type="radio"/>	34	GROUND	
24	GPIO 19 (PCM FS)	35	<input type="radio"/>	<input type="radio"/>	36	GPIO 16	27
25	GPIO 26	37	<input type="radio"/>	<input type="radio"/>	38	GPIO 20 (PCM DIN)	28
	GROUND	39	<input type="radio"/>	<input type="radio"/>	40	GPIO 21 (PCM DOUT)	29

NOTE: Alternate pin functions are also available. Check the datasheet for more information.

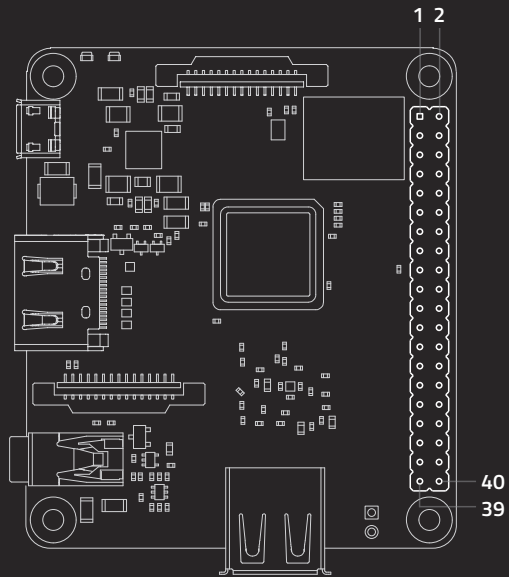



WIRING PI #	MAIN FUNCTIONS	#			#	MAIN FUNCTIONS	WIRING PI #
	3V3 POWER	1	<input type="checkbox"/>	<input type="radio"/>	2	5V POWER	
8	GPIO 2 (I2C1 SDA)	3	<input type="radio"/>	<input type="radio"/>	4	5V POWER	
9	GPIO 3 (I2C1 SCL)	5	<input type="radio"/>	<input type="radio"/>	6	GROUND	
7	GPIO 4 (GPCLK0)	7	<input type="radio"/>	<input type="radio"/>	8	GPIO 14 (UART TX)	15
	GROUND	9	<input type="radio"/>	<input type="radio"/>	10	GPIO 15 (UART RX)	16
0	GPIO 17	11	<input type="radio"/>	<input type="radio"/>	12	GPIO 18 (PCM CLK)	1
2	GPIO 27	13	<input type="radio"/>	<input type="radio"/>	14	GROUND	
3	GPIO 22	15	<input type="radio"/>	<input type="radio"/>	16	GPIO 23	4
	3V3 POWER	17	<input type="radio"/>	<input type="radio"/>	18	GPIO 24	5
12	GPIO 10 (SPI0 MOSI)	19	<input type="radio"/>	<input type="radio"/>	20	GROUND	
13	GPIO 9 (SPI0 MISO)	21	<input type="radio"/>	<input type="radio"/>	22	GPIO 25	6
14	GPIO 11 (SPI0 SCLK)	23	<input type="radio"/>	<input type="radio"/>	24	GPIO 8 (SPI0 CE0)	10
	GROUND	25	<input type="radio"/>	<input type="radio"/>	26	GPIO 7 (SPI0 CE1)	11
30	GPIO 0 (EEPROM SDA)	27	<input type="radio"/>	<input type="radio"/>	28	GPIO 1 (EEPROM SCL)	31
21	BCM 5	29	<input type="radio"/>	<input type="radio"/>	30	GROUND	
22	BCM 6	31	<input type="radio"/>	<input type="radio"/>	32	GPIO 12 (PWM0)	26
23	GPIO 13 (PWM1)	33	<input type="radio"/>	<input type="radio"/>	34	GROUND	
24	GPIO 19 (PCM FS)	35	<input type="radio"/>	<input type="radio"/>	36	GPIO 16	27
25	GPIO 26	37	<input type="radio"/>	<input type="radio"/>	38	GPIO 20 (PCM DIN)	28
	GROUND	39	<input type="radio"/>	<input type="radio"/>	40	GPIO 21 (PCM DOUT)	29

NOTE: Alternate pin functions are also available. Check the datasheet for more information.

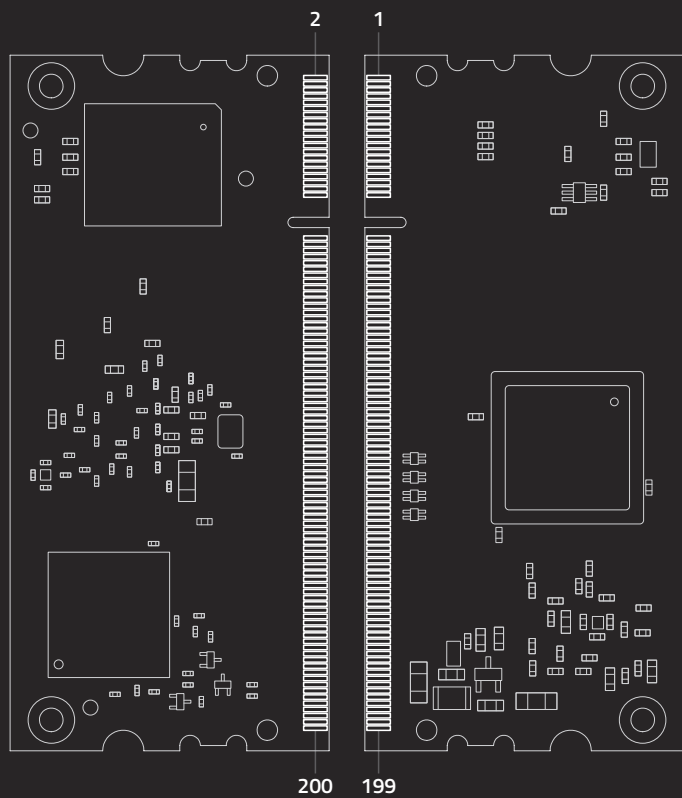

#	NAME	#	NAME	#	NAME	#	NAME
1	GND	26	GND	51	GPIO14	76	GPIO42
2	EMMC_DISABLE_N	27	GPIO8	52	GPIO34	77	GPIO23
3	GPIO0	28	GPIO28	53	GPIO15	78	GPIO43
4	NC	29	GPIO9	54	GPIO35	79	GND
5	GPIO1	30	GPIO29	55	GND	80	GND
6	NC	31	GND	56	GND	81	GPIO24
7	GND	32	GND	57	GPIO16	82	GPIO44
8	GND	33	GPIO10	58	GPIO36	83	GPIO25
9	GPIO2	34	GPIO30	59	GPIO17	84	GPIO45
10	NC	35	GPIO11	60	GPIO37	85	GND
11	GPIO3	36	GPIO31	61	GND	86	GND
12	NC	37	GND	62	GND	87	GPIO26
13	GND	38	GND	63	GPIO18	88	HDMI_HPD_N_1V8
14	GND	39	GPIO0-27_VDD	64	GPIO38	89	GPIO27
15	GPIO4	40	GPIO0-27_VDD	65	GPIO19	90	EMMC_EN_N_1V8
16	NC	41	GPIO28-45_VDD	66	GPIO39	91	GND
17	GPIO5	42	GPIO28-45_VDD	67	GND	92	GND
18	NC	43	GND	68	GND	93	DSIO_DN1
19	GND	44	GND	69	GPIO20	94	DSI1_DP0
20	GND	45	GPIO12	70	GPIO40	95	DSIO_DP1
21	GPIO6	46	GPIO32	71	GPIO21	96	DSI1_DN0
22	NC	47	GPIO13	72	GPIO41	97	GND
23	GPIO7	48	GPIO33	73	GND	98	GND
24	NC	49	GND	74	GND	99	DSIO_DN0
25	GND	50	GND	75	GPIO22	100	DSI1_CP

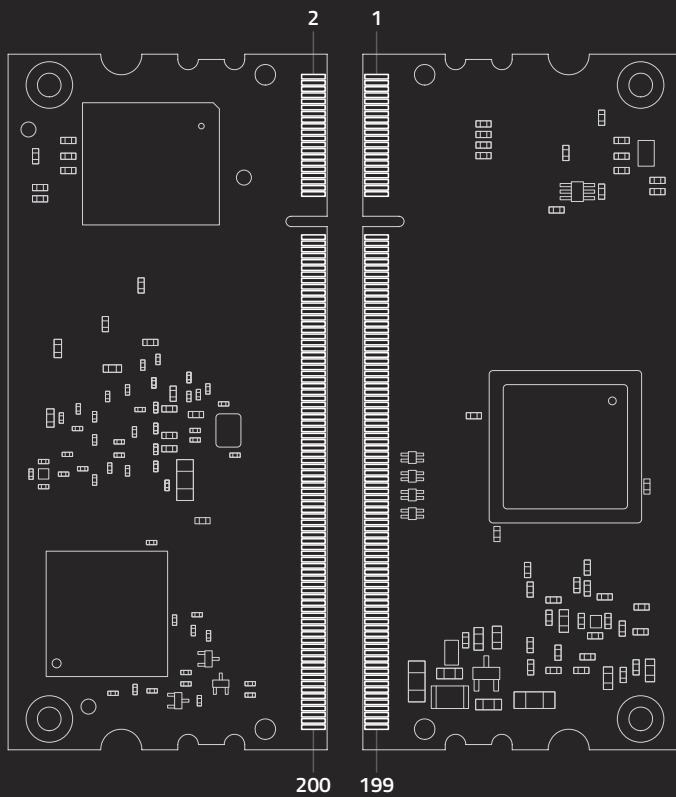

#	NAME	#	NAME	#	NAME	#	NAME
101	DSIO_DPO	126	NC	151	GND	176	VC_TMS
102	DSI1_CN	127	GND	152	GND	177	RUN
103	GND	128	NC	153	CAM1_DP1	178	VC_TDO
104	GND	129	HDMI_D2_N	154	NC	179	VDD_CORE*
105	DSIO_CN	130	NC	155	CAM1_DN1	180	VC_TCK
106	DSI1_DP3	131	HDMI_D2_P	156	NC	181	GND
107	DSIO_CP	132	NC	157	GND	182	GND
108	DSI1_DN3	133	GND	158	NC	183	1V8
109	GND	134	GND	159	CAM1_DPO	184	1V8
110	GND	135	CAM1_DP3	160	NC	185	1V8
111	HDMI_CLK_N	136	CAM0_DPO	161	CAM1_DN0	186	1V8
112	DSI1_DP2	137	CAM1_DN3	162	NC	187	GND
113	HDMI_CLK_P	138	CAM0_DN0	163	GND	188	GND
114	DSI1_DN2	139	GND	164	GND	189	VDAC
115	GND	140	GND	165	USB_DP	190	VDAC
116	GND	141	CAM1_DP2	166	TVDAC	191	3V3
117	HDMI_DO_N	142	CAM0_CP	167	USB_DM	192	3V3
118	DSI1_DP1	143	CAM1_DN2	168	USB_OTGID	193	3V3
119	HDMI_DO_P	144	CAM0_CN	169	GND	194	3V3
120	DSI1_DN1	145	GND	170	GND	195	GND
121	GND	146	GND	171	HDMI_CEC	196	GND
122	GND	147	CAM1_CP	172	VC_TRST_N	197	VBAT
123	HDMI_D1_N	148	CAM0_DP1	173	HDMI_SDA	198	VBAT
124	NC	149	CAM1_CN	174	VC_TDI	199	VBAT
125	HDMI_D1_P	150	CAM0_DN1	175	HDMI_SCL	200	VBAT

\* Do not connect

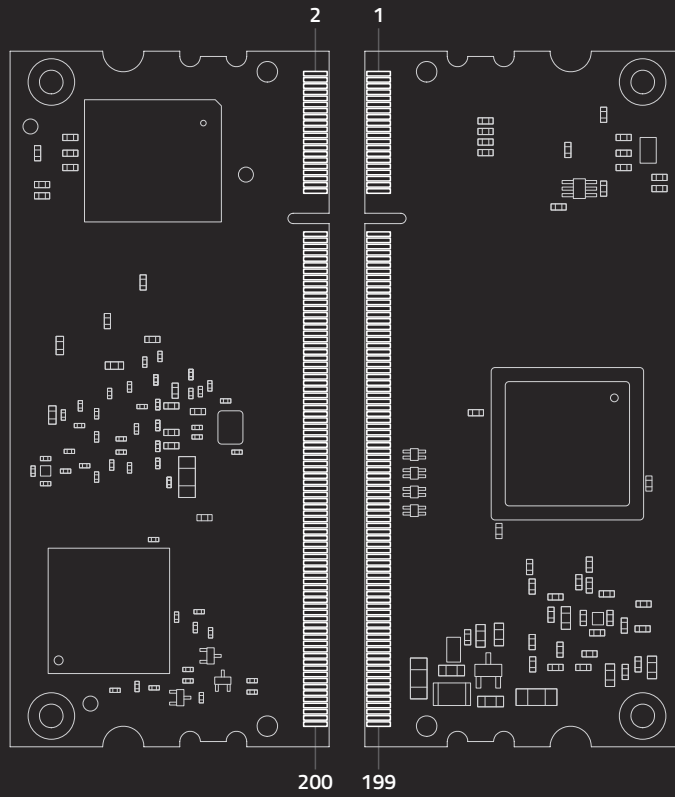

#	NAME	#	NAME	#	NAME	#	NAME
1	GND	26	GND	51	GPIO14	76	GPIO42
2	EMMC_DISABLE_N	27	GPIO8	52	GPIO34	77	GPIO23
3	GPIO0	28	GPIO28	53	GPIO15	78	GPIO43
4	SDX_VDD	29	GPIO9	54	GPIO35	79	GND
5	GPIO1	30	GPIO29	55	GND	80	GND
6	SDX_VDD	31	GND	56	GND	81	GPIO24
7	GND	32	GND	57	GPIO16	82	GPIO44
8	GND	33	GPIO10	58	GPIO36	83	GPIO25
9	GPIO2	34	GPIO30	59	GPIO17	84	GPIO45
10	SDX_CLK	35	GPIO11	60	GPIO37	85	GND
11	GPIO3	36	GPIO31	61	GND	86	GND
12	SDX_CMD	37	GND	62	GND	87	GPIO26
13	GND	38	GND	63	GPIO18	88	HDMI_HPD_N_1V8
14	GND	39	GPIO0-27_VDD	64	GPIO38	89	GPIO27
15	GPIO4	40	GPIO0-27_VDD	65	GPIO19	90	EMMC_EN_N_1V8
16	SDX_D0	41	GPIO28-45_VDD	66	GPIO39	91	GND
17	GPIO5	42	GPIO28-45_VDD	67	GND	92	GND
18	SDX_D1	43	GND	68	GND	93	DSIO_DN1
19	GND	44	GND	69	GPIO20	94	DSI1_DP0
20	GND	45	GPIO12	70	GPIO40	95	DSIO_DP1
21	GPIO6	46	GPIO32	71	GPIO21	96	DSI1_DN0
22	SDX_D2	47	GPIO13	72	GPIO41	97	GND
23	GPIO7	48	GPIO33	73	GND	98	GND
24	SDX_D3	49	GND	74	GND	99	DSIO_DN0
25	GND	50	GND	75	GPIO22	100	DSI1_CP

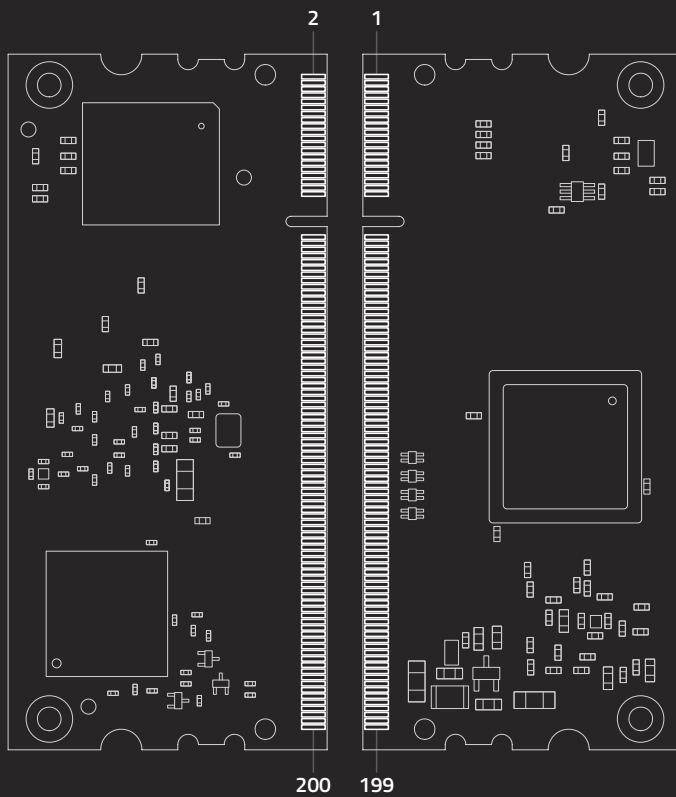



#	NAME	#	NAME	#	NAME	#	NAME
101	DSIO_DPO	126	NC	151	GND	176	VC_TMS
102	DSI1_CN	127	GND	152	GND	177	RUN
103	GND	128	NC	153	CAM1_DP1	178	VC_TDO
104	GND	129	HDMI_D2_N	154	NC	179	VDD_CORE*
105	DSIO_CN	130	NC	155	CAM1_DN1	180	VC_TCK
106	DSI1_DP3	131	HDMI_D2_P	156	NC	181	GND
107	DSIO_CP	132	NC	157	GND	182	GND
108	DSI1_DN3	133	GND	158	NC	183	1V8
109	GND	134	GND	159	CAM1_DPO	184	1V8
110	GND	135	CAM1_DP3	160	NC	185	1V8
111	HDMI_CLK_N	136	CAM0_DPO	161	CAM1_DN0	186	1V8
112	DSI1_DP2	137	CAM1_DN3	162	NC	187	GND
113	HDMI_CLK_P	138	CAM0_DN0	163	GND	188	GND
114	DSI1_DN2	139	GND	164	GND	189	VDAC
115	GND	140	GND	165	USB_DP	190	VDAC
116	GND	141	CAM1_DP2	166	TVDAC	191	3V3
117	HDMI_DO_N	142	CAM0_CP	167	USB_DM	192	3V3
118	DSI1_DP1	143	CAM1_DN2	168	USB_OTGID	193	3V3
119	HDMI_DO_P	144	CAM0_CN	169	GND	194	3V3
120	DSI1_DN1	145	GND	170	GND	195	GND
121	GND	146	GND	171	HDMI_CEC	196	GND
122	GND	147	CAM1_CP	172	VC_TRST_N	197	VBAT
123	HDMI_D1_N	148	CAM0_DP1	173	HDMI_SDA	198	VBAT
124	NC	149	CAM1_CN	174	VC_TDI	199	VBAT
125	HDMI_D1_P	150	CAM0_DN1	175	HDMI_SCL	200	VBAT

\* Do not connect

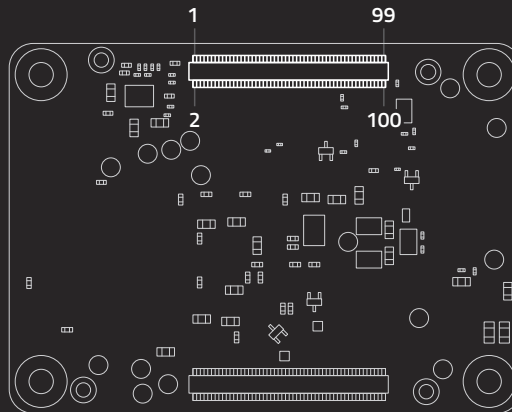
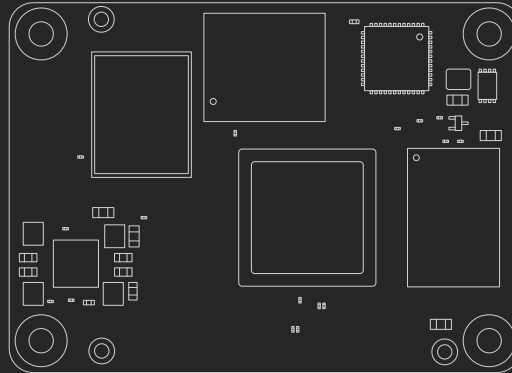

#	NAME	#	NAME	#	NAME	#	NAME
1	GND	26	GPIO19	51	GPIO15	76	RESERVED
2	GND	27	GPIO20	52	GND	77	+5V (INPUT)
3	ETHERNET_PAIR3_P	28	GPIO13	53	GND	78	GPIO_VREF
4	ETHERNET_PAIR1_P	29	GPIO16	54	GPIO4	79	+5V (INPUT)
5	ETHERNET_PAIR3_N	30	GPIO6	55	GPIO14	80	SCL0
6	ETHERNET_PAIR1_N	31	GPIO12	56	GPIO3	81	+5V (INPUT)
7	GND	32	GND	57	SD_CLK	82	SDA0
8	GND	33	GND	58	GPIO2	83	+5V (INPUT)
9	ETHERNET_PAIR2_N	34	GPIO5	59	GND	84	CM4_3.3V (OUTPUT)
10	ETHERNET_PAIR0_N	35	ID_SC	60	GND	85	+5V (INPUT)
11	ETHERNET_PAIR2_P	36	ID_SD	61	SD_DAT3	86	CM4_3.3V (OUTPUT)
12	ETHERNET_PAIR0_P	37	GPIO7	62	SD_CMD	87	+5V (INPUT)
13	GND	38	GPIO11	63	SD_DAT0	88	CM4_1.8V (OUTPUT)
14	GND	39	GPIO8	64	SD_DAT5	89	WL_NDISABLE
15	ETHERNET_NLED3	40	GPIO9	65	GND	90	CM4_1.8V (OUTPUT)
16	ETHERNET_SYNC_IN	41	GPIO25	66	GND	91	BT_NDISABLE
17	ETHERNET_NLED2	42	GND	67	SD_DAT1	92	RUN_PG
18	ETHERNET_SYNC_OUT	43	GND	68	SD_DAT4	93	NRPIBOOT
19	ETHERNET_NLED1	44	GPIO10	69	SD_DAT2	94	ANALOGIP1
20	EEPROM_NWP	45	GPIO24	70	SD_DAT7	95	PI_LED_NPWR
21	PI_NLED_ACTIVITY	46	GPIO22	71	GND	96	ANALOGIPO
22	GND	47	GPIO23	72	SD_DAT6	97	CAMERA_GPIO
23	GND	48	GPIO27	73	SD_VDD_OVERRIDE	98	GND
24	GPIO26	49	GPIO18	74	GND	99	GLOBAL_EN
25	GPIO21	50	GPIO17	75	SD_PWR_ON	100	NEXTRST

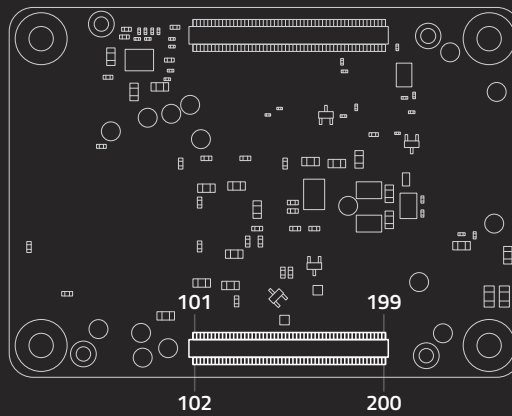
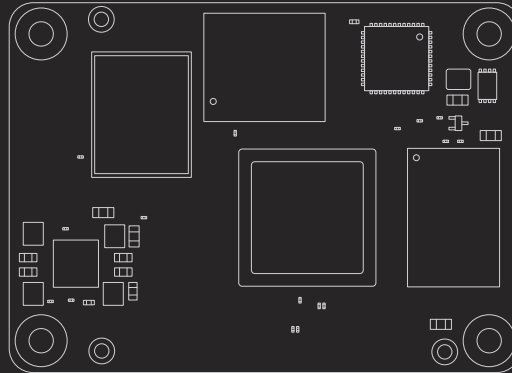

#	NAME	#	NAME	#	NAME	#	NAME
101	USB_OTG_ID	126	GND	151	HDMI0_CEC	176	HDMI0_TX1_P
102	PCIE_CLK_NREQ	127	CAM1_C_N	152	HDMI1_TX1_P	177	DSI1_D0_P
103	USB_N	128	CAM0_DO_N	153	HDMI0_HOTPLUT	178	HDMI0_TX1_N
104	RESERVED	129	CAM1_C_P	154	HDMI1_TX1_N	179	GND
105	USB_P	130	CAM0_DO_P	155	GND	180	GND
106	RESERVED	131	GND	156	GND	181	DSI1_D1_N
107	GND	132	GND	157	DSIO_DO_N	182	HDMI0_TX0_P
108	GND	133	CAM1_D2_N	158	HDMI1_TX0_P	183	DSI1_D1_P
109	PCIE_Nrst	134	CAM0_D1_N	159	DSIO_DO_P	184	HDMI0_TX0_N
110	PCIE_CLK_P	135	CAM1_D2_P	160	HDMI1_TX0_N	185	GND
111	VDAC_COMP	136	CAM0_D1_P	161	GND	186	GND
112	PCIE_CLK_N	137	GND	162	GND	187	DSI1_C_N
113	GND	138	GND	163	DSIO_D1_N	188	HDMI0_CLK_P
114	GND	139	CAM1_D3_N	164	HDMI1_CLK_P	189	DSI1_C_P
115	CAM1_DO_N	140	CAM0_C_N	165	DSIO_D1_P	190	HDMI0_CLK_N
116	PCIE_RX_P	141	CAM1_D3_P	166	HDMI1_CLK_N	191	GND
117	CAM1_DO_P	142	CAM0_C_P	167	GND	192	GND
118	PCIE_RX_N	143	HDMI1_HOTPLUT	168	GND	193	DSI1_D2_N
119	GND	144	GND	169	DSIO_C_N	194	DSI1_D3_N
120	GND	145	HDMI1_SDA	170	HDMI0_TX2_P	195	DSI1_D2_P
121	CAM1_D1_N	146	HDMI1_TX2_P	171	DSIO_C_P	196	DSI1_D3_P
122	PCIE_TX_P	147	HDMI1_SCL	172	HDMI0_TX2_N	197	GND
123	CAM1_D1_P	148	HDMI1_TX2_N	173	GND	198	GND
124	PCIE_TX_N	149	HDMI1_CEC	174	GND	199	HDMI0_SDA
125	GND	150	GND	175	DSI1_DO_N	200	HDMI0_SCL

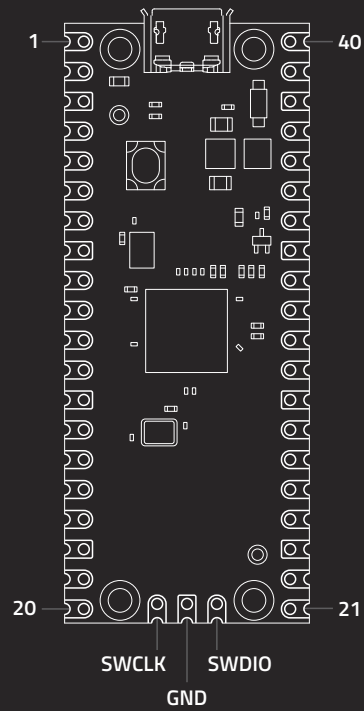

#	MAIN	SPI	I2C	UART	#	MAIN	SPI / ADC	I2C	UART
1	GP0	SPI0 RX	I2C0 SDA	UART0 TX	21	GP16	SPI0 RX	I2C0 SDA	UART0 TX
2	GP1	SPI0 CSN	I2C0 SCL	UART0 RX	22	GP17	SPI0 CSN	I2C0 SCL	UART0 RX
3	GROUND				23	GROUND			
4	GP2	SPI0 SCK	I2C1 SDA		24	GP18	SPI0 SCK	I2C1 SDA	
5	GP3	SPI0 TX	I2C1 SCL		25	GP19	SPI0 TX	I2C1 SCL	
6	GP4	SPI0 RX	I2C0 SDA	UART1 TX	26	GP20		I2C0 SDA	
7	GP5	SPI0 CSN	I2C0 SCL	UART1 RX	27	GP21		I2C0 SCL	
8	GROUND				28	GROUND			
9	GP6	SPI0 SCK	I2C1 SDA		29	GP22			
10	GP7	SPI0 TX	I2C1 SCL		30	RUN			
11	GP8	SPI1 RX	I2C0 SDA	UART1 TX	31	GP26	ADC0	I2C1 SDA	
12	GP9	SPI1 CSN	I2C0 SCL	UART1 RX	32	GP27	ADC1	I2C1 SCL	
13	GROUND				33	GROUND	AGROUND		
14	GP10	SPI1 SCK	I2C1 SDA		34	GP28	ADC2		
15	GP11	SPI1 TX	I2C1 SCL		35		ADC_VREF		
16	GP12	SPI1 RX	I2C0 SDA	UART0 TX	36	3V3 (OUT)			
17	GP13	SPI1 CSN	I2C0 SCL	UART0 RX	37	3V3_EN			
18	GROUND				38	GROUND			
19	GP14	SPI1 SCK	I2C1 SDA		39	VSYS			
20	GP15	SPI1 TX	I2C1 SCL		40	VBUS			

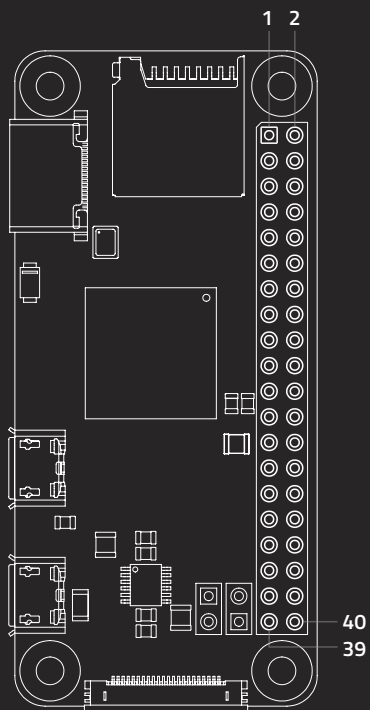



WIRING PI #	MAIN FUNCTIONS	#			#	MAIN FUNCTIONS	WIRING PI #
	3V3 POWER	1	<input type="checkbox"/>	<input type="radio"/>	2	5V POWER	
8	GPIO 2 (I2C1 SDA)	3	<input type="radio"/>	<input type="radio"/>	4	5V POWER	
9	GPIO 3 (I2C1 SCL)	5	<input type="radio"/>	<input type="radio"/>	6	GROUND	
7	GPIO 4 (GPCLK0)	7	<input type="radio"/>	<input type="radio"/>	8	GPIO 14 (UART TX)	15
	GROUND	9	<input type="radio"/>	<input type="radio"/>	10	GPIO 15 (UART RX)	16
0	GPIO 17	11	<input type="radio"/>	<input type="radio"/>	12	GPIO 18 (PCM CLK)	1
2	GPIO 27	13	<input type="radio"/>	<input type="radio"/>	14	GROUND	
3	GPIO 22	15	<input type="radio"/>	<input type="radio"/>	16	GPIO 23	4
	3V3 POWER	17	<input type="radio"/>	<input type="radio"/>	18	GPIO 24	5
12	GPIO 10 (SPI0 MOSI)	19	<input type="radio"/>	<input type="radio"/>	20	GROUND	
13	GPIO 9 (SPI0 MISO)	21	<input type="radio"/>	<input type="radio"/>	22	GPIO 25	6
14	GPIO 11 (SPI0 SCLK)	23	<input type="radio"/>	<input type="radio"/>	24	GPIO 8 (SPI0 CE0)	10
	GROUND	25	<input type="radio"/>	<input type="radio"/>	26	GPIO 7 (SPI0 CE1)	11
30	GPIO 0 (EEPROM SDA)	27	<input type="radio"/>	<input type="radio"/>	28	GPIO 1 (EEPROM SCL)	31
21	BCM 5	29	<input type="radio"/>	<input type="radio"/>	30	GROUND	
22	BCM 6	31	<input type="radio"/>	<input type="radio"/>	32	GPIO 12 (PWMO)	26
23	GPIO 13 (PWM1)	33	<input type="radio"/>	<input type="radio"/>	34	GROUND	
24	GPIO 19 (PCM FS)	35	<input type="radio"/>	<input type="radio"/>	36	GPIO 16	27
25	GPIO 26	37	<input type="radio"/>	<input type="radio"/>	38	GPIO 20 (PCM DIN)	28
	GROUND	39	<input type="radio"/>	<input type="radio"/>	40	GPIO 21 (PCM DOUT)	29

NOTE: Alternate pin functions are also available. Check the datasheet for more information.

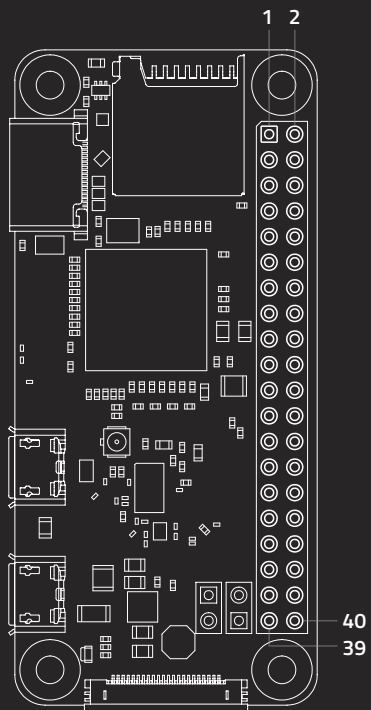

WIRING PI #	MAIN FUNCTIONS	#			#	MAIN FUNCTIONS	WIRING PI #
	3V3 POWER	1	<input type="checkbox"/>	<input type="radio"/>	2	5V POWER	
8	GPIO 2 (I2C1 SDA)	3	<input type="radio"/>	<input type="radio"/>	4	5V POWER	
9	GPIO 3 (I2C1 SCL)	5	<input type="radio"/>	<input type="radio"/>	6	GROUND	
7	GPIO 4 (GPCLK0)	7	<input type="radio"/>	<input type="radio"/>	8	GPIO 14 (UART TX)	15
	GROUND	9	<input type="radio"/>	<input type="radio"/>	10	GPIO 15 (UART RX)	16
0	GPIO 17	11	<input type="radio"/>	<input type="radio"/>	12	GPIO 18 (PCM CLK)	1
2	GPIO 27	13	<input type="radio"/>	<input type="radio"/>	14	GROUND	
3	GPIO 22	15	<input type="radio"/>	<input type="radio"/>	16	GPIO 23	4
	3V3 POWER	17	<input type="radio"/>	<input type="radio"/>	18	GPIO 24	5
12	GPIO 10 (SPI0 MOSI)	19	<input type="radio"/>	<input type="radio"/>	20	GROUND	
13	GPIO 9 (SPI0 MISO)	21	<input type="radio"/>	<input type="radio"/>	22	GPIO 25	6
14	GPIO 11 (SPI0 SCLK)	23	<input type="radio"/>	<input type="radio"/>	24	GPIO 8 (SPI0 CE0)	10
	GROUND	25	<input type="radio"/>	<input type="radio"/>	26	GPIO 7 (SPI0 CE1)	11
30	GPIO 0 (EEPROM SDA)	27	<input type="radio"/>	<input type="radio"/>	28	GPIO 1 (EEPROM SCL)	31
21	BCM 5	29	<input type="radio"/>	<input type="radio"/>	30	GROUND	
22	BCM 6	31	<input type="radio"/>	<input type="radio"/>	32	GPIO 12 (PWM0)	26
23	GPIO 13 (PWM1)	33	<input type="radio"/>	<input type="radio"/>	34	GROUND	
24	GPIO 19 (PCM FS)	35	<input type="radio"/>	<input type="radio"/>	36	GPIO 16	27
25	GPIO 26	37	<input type="radio"/>	<input type="radio"/>	38	GPIO 20 (PCM DIN)	28
	GROUND	39	<input type="radio"/>	<input type="radio"/>	40	GPIO 21 (PCM DOUT)	29



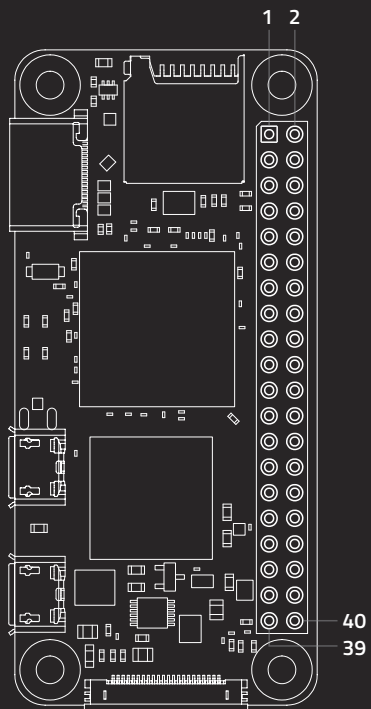



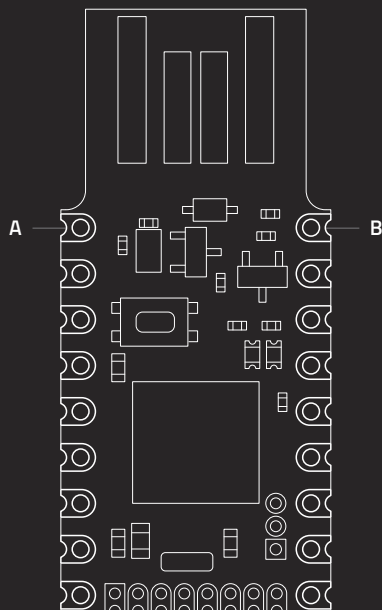

NOTE: Alternate pin functions are also available. Check the datasheet for more information.











WIRING PI #	MAIN FUNCTIONS	#			#	MAIN FUNCTIONS	WIRING PI #
	3V3 POWER	1	<input type="checkbox"/>	<input type="radio"/>	2	5V POWER	
8	GPIO 2 (I2C1 SDA)	3	<input type="radio"/>	<input type="radio"/>	4	5V POWER	
9	GPIO 3 (I2C1 SCL)	5	<input type="radio"/>	<input type="radio"/>	6	GROUND	
7	GPIO 4 (GPCLK0)	7	<input type="radio"/>	<input type="radio"/>	8	GPIO 14 (UART TX)	15
	GROUND	9	<input type="radio"/>	<input type="radio"/>	10	GPIO 15 (UART RX)	16
0	GPIO 17	11	<input type="radio"/>	<input type="radio"/>	12	GPIO 18 (PCM CLK)	1
2	GPIO 27	13	<input type="radio"/>	<input type="radio"/>	14	GROUND	
3	GPIO 22	15	<input type="radio"/>	<input type="radio"/>	16	GPIO 23	4
	3V3 POWER	17	<input type="radio"/>	<input type="radio"/>	18	GPIO 24	5
12	GPIO 10 (SPI0 MOSI)	19	<input type="radio"/>	<input type="radio"/>	20	GROUND	
13	GPIO 9 (SPI0 MISO)	21	<input type="radio"/>	<input type="radio"/>	22	GPIO 25	6
14	GPIO 11 (SPI0 SCLK)	23	<input type="radio"/>	<input type="radio"/>	24	GPIO 8 (SPI0 CE0)	10
	GROUND	25	<input type="radio"/>	<input type="radio"/>	26	GPIO 7 (SPI0 CE1)	11
30	GPIO 0 (EEPROM SDA)	27	<input type="radio"/>	<input type="radio"/>	28	GPIO 1 (EEPROM SCL)	31
21	BCM 5	29	<input type="radio"/>	<input type="radio"/>	30	GROUND	
22	BCM 6	31	<input type="radio"/>	<input type="radio"/>	32	GPIO 12 (PWM0)	26
23	GPIO 13 (PWM1)	33	<input type="radio"/>	<input type="radio"/>	34	GROUND	
24	GPIO 19 (PCM FS)	35	<input type="radio"/>	<input type="radio"/>	36	GPIO 16	27
25	GPIO 26	37	<input type="radio"/>	<input type="radio"/>	38	GPIO 20 (PCM DIN)	28
	GROUND	39	<input type="radio"/>	<input type="radio"/>	40	GPIO 21 (PCM DOUT)	29

NOTE: Alternate pin functions are also available. Check the datasheet for more information.







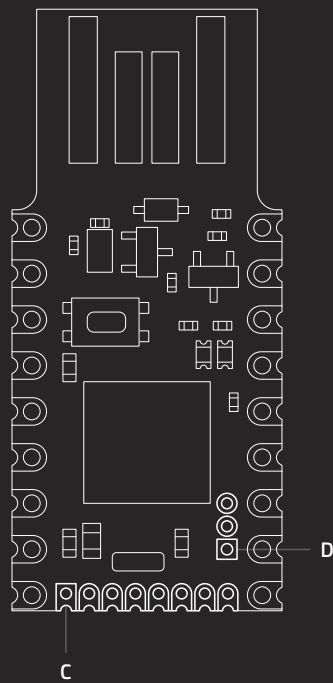





A	NAME			
	GND			
	VBAT			
	3.3			
	B3	I2C2_SDA	PWM (TIM2_CH2)	SPI3_SCK SPI1_SCK
	B4	I2C3_SDA	PWM (TIM3_CH1)	SPI1_MISO SPI3_MISO
	B5	PWM (TIM3_CH2)	SPI1_MOSI	SPI3_MOSI
	B6	I2C1_SCL	PWM (TIM4_CH1)	USART1_TX
	B7	I2C1_SDA	PWM (TIM4_CH2)	USART1_RX
	A8	I2C3_SCL	PWM (TIM1_CH1)	USART1_CK

B	NAME		
	BAT_IN		
	B15	PWM (TIM1_CH3N)	SPI2_MOSI
	B14	PWM (TIM1_CH2N)	SPI2_MISO
	B13	PWM (TIM1_CH1N)	SPI2_SCK
	B10	I2C2_SCL	PWM (TIM2_CH3) SPI2_SCK
	B1	ADC1_IN9	PWM (TIM1_CH3N, TIM3_CH4)
	A7	ADC1_IN7	PWM (TIM1_CH1N, TIM3_CH2) SPI1_MOSI
	A6	ADC1_IN6	PWM (TIM3_CH1) SPI1_MISO
	A5	ADC1_IN5	PWM (TIM2_CH1) SPI1_SCK





C	NAME		
	B8	I2C1_SCL	PWM (TIM10_CH1, TIM4_CH3)
	B9	I2C1_SDA	PWM (TIM11_CH1, TIM4_CH4)
	A10	PWM (TIM1_CH3)	USART1_RX
	A0	ADC1_IN0	PWM (TIM2_CH1)
	A1	ADC1_IN1	PWM (TIM2_CH2)
	A2	ADC1_IN2	PWM (TIM2_CH3, TIM9_CH1)    USART2_TX
	A3	ADC1_IN3	PWM (TIM2_CH4, TIM9_CH2)    USART2_RX
	A4	ADC1_IN4	USART2_CK

D	NAME
	GND
	3.3V
	VBAT

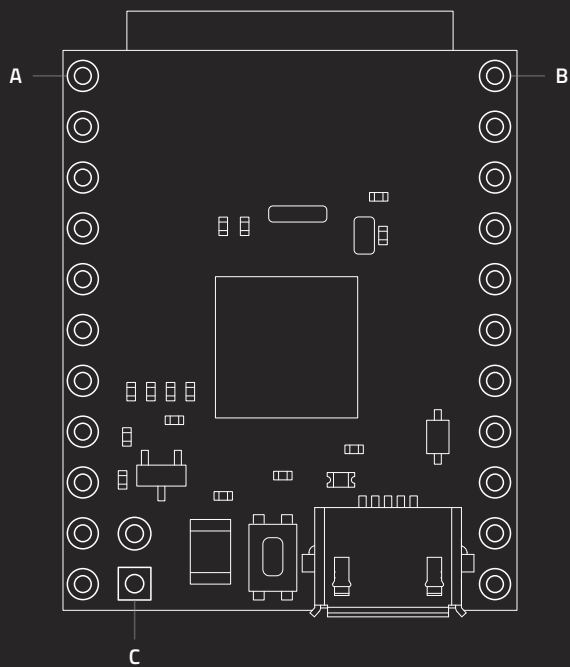

A	NAME			
<input type="radio"/>	A0	PWM (TIM2_CH1)	ADC1_IN0	
<input type="radio"/>	A1	PWM (TIM2_CH2)	ADC1_IN1	
<input type="radio"/>	A4	USART2_CK	ADC1_IN4	
<input type="radio"/>	A5	SPI1_SCK	PWM (TIM2_CH1)	ADC1_IN5
<input type="radio"/>	A6	SPI1_MISO	PWM (TIM3_CH1)	ADC1_IN6
<input type="radio"/>	A7	SPI1_MOSI	PWM (TIM1_CH1N, TIM3_CH2)	ADC1_IN7
<input type="radio"/>	B1	PWM (TIM1_CH3N, TIM3_CH4)	ADC1_IN9	
<input type="radio"/>	B10	SPI2_SCK	PWM (TIM2_CH3)	I2C2_SCL
<input type="radio"/>	B13	SPI2_SCK	PWM (TIM1_CH1N)	
<input type="radio"/>	B14	SPI2_MISO	PWM (TIM1_CH2N)	
<input type="radio"/>	B15	SPI2_MOSI	PWM (TIM1_CH3N)	

B	NAME			
<input type="radio"/>	B0	ADC1_IN8	PWM (TIM1_CH2N, TIM3_CH3)	
<input type="radio"/>	B9	I2C1_SDA	PWM (TIM11_CH1, TIM4_CH4)	
<input type="radio"/>	B8	I2C1_SCL	PWM (TIM10_CH1, TIM4_CH3)	
<input type="radio"/>	B7	I2C1_SDA	PWM (TIM4_CH2)	USART1_RX
<input type="radio"/>	B6	I2C1_SCL	PWM (TIM4_CH1)	USART1_TX
<input type="radio"/>	B5	PWM (TIM3_CH2)	SPI1_MOSI	SPI3_MOSI
<input type="radio"/>	B4	I2C3_SDA	PWM (TIM3_CH1)	SPI1_MISO    SPI3_MISO
<input type="radio"/>	B3	I2C2_SDA	PWM (TIM2_CH2)	SPI3_SCK    SPI1_SCK
<input type="radio"/>	3.3 <i>(3.3v output from the on-board voltage regulator)</i>			
<input type="radio"/>	VUSB <i>(This pin is connected directly to USB 5V. Only use to power the Espruino if micro USB is unplugged)</i>			
<input type="radio"/>	GND			

C	NAME			
<input type="radio"/>	A10	PWN (TIM1_CH3)	USART1_RX	
<input type="checkbox"/>	A8	I2C3_SCL	PWM (TIM1_CH1)	USART1_CK

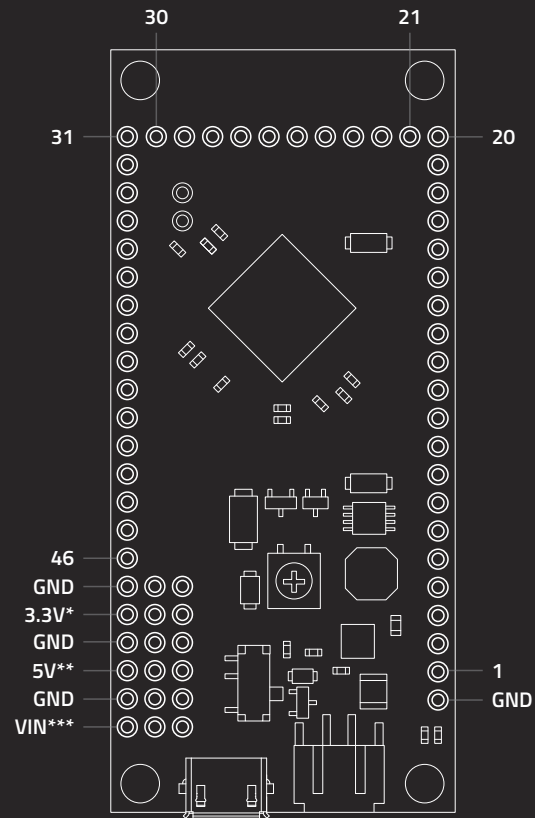

#	PIC	FUNCTIONS	#	PIC	FUNCTIONS
1	31	SDA2/RP10/GD4/CN17/RF4	24	1	VSYNC/CN63/RE5
2	32	SCL2/RP17/GD5/CN18/RF5	25	2	GD12/SCL3/CN64/RE6
3	42	RTCC/DMLN/RP2/CN53/RD8	26	3	GD13/SDA3/CN65/RE7
4	43	DPLN/SDA1/RP4/GD8/CN54/RD9	27	4	C1IND/RP21/CN8/RG6
5	44	SCL1/RP3/GD6/CN55/RD10	28	5	C1INC/RP26/CN9/RG7
6	45	RP12/GD7/CN56/RD11	29	6	C2IND/RP19/GD14/CN10/RG8
7	46	DMH/RP11/INT0/CN49/RD0	30	8	C2INC/RP27/GD15/CN11/RG9
8	47	SOSCI/C3IND/CN1/RC13	31	11	PGEC3/AN5/C1INA/VBUSON/RP18/CN7/RB5
9	48	SOSCO/SCLKI/T1CK/C3INC/RPI37/CN0/RC14	32	12	PGED3/AN4/C1INB/USBOEN/RP28/CN6/RB4
10	49	VCPCON/RP24/GD9/VBUSCHG/CN50/RD1	33	13	AN3/C2INA/VPIO/CN5/RB3
11	50	DPH/RP23/CN51/RD2	34	14	AN2/C2INB/VMIO/RP13/CN4/RB2
12	51	RP22/GEN/CN52/RD3	35	15	PGEC1/AN1/VREF-/RP1/CN3/RB1
13	52	RP25/GCLK/CN13/RD4	36	16	PGED1/AN0/VREF+/RP0/CN2/RB0
14	53	RP20/GPWR/CN14/RD5	37	17	PGEC2/AN6/RP6/CN24/RB6
15	54	C3INB/CN15/RD6	38	18	PGED2/AN7/RP7/RCV/CN25/RB7
16	55	C3INA/SESSEND/CN16/RD7	39	21	AN8/RP8/CN26/RB8
17	58	GD10/VBUSST/VCMPST1/VBUSVLD/CN68/RF0	40	22	AN9/RP9/CN27/RB9
18	59	GD11/VCMPST2/SESSVLD/CN69/RF1	41	23	TMS/CVREF/AN10/CN28/RB10
19	60	GD0/CN58/RE0	42	24	TDO/AN11/CN29/RB11
20	61	GD1/CN59/RE1	43	27	TCK/AN12/CTEDG2/CN30/RB12
21	62	GD2/CN60/RE2	44	28	TDI/AN13/CTEDG1/CN31/RB13
22	63	GD3/CN61/RE3	45	29	AN14/CTPLS/RP14/CN32/RB14
23	64	HSYNC/CN62/RE4	46	30	AN15/RP29/REF0/CN12/RB15

\*3.3V output from the on-board regulator. \*\*5V output from the on-board regulator. \*\*\*Used for outputting the supply voltage to your circuit, or as an alternative input to the power jack.

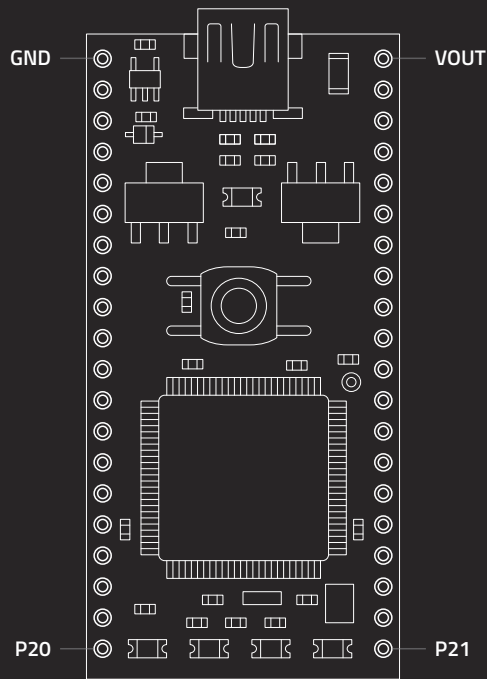

	NAME		
<input type="radio"/>	GND	0V	
<input type="radio"/>	VIN	4.5V - 9.0V IN	
<input type="radio"/>	VB		
<input type="radio"/>	NR		
<input type="radio"/>	P5	SPI (MOSI)	
<input type="radio"/>	P6	SPI (MISO)	
<input type="radio"/>	P7	SPI (SCK)	
<input type="radio"/>	P8		
<input type="radio"/>	P9	SERIAL (TX)	I2C (SDA)
<input type="radio"/>	P10	SERIAL (RX)	I2C (SCL)
<input type="radio"/>	P11		SPI (MOSI)
<input type="radio"/>	P12		SPI (MISO)
<input type="radio"/>	P13	SERIAL (TX)	SPI (SCK)
<input type="radio"/>	P14	SERIAL (RX)	
<input type="radio"/>	P15	ANALOGIN	
<input type="radio"/>	P16	ANALOGIN	
<input type="radio"/>	P17	ANALOGIN	
<input type="radio"/>	P18	ANALOGIN	ANALOGOUT
<input type="radio"/>	P19	ANALOGIN	
<input type="radio"/>	P20	ANALOGIN	

	NAME		
<input type="radio"/>	VOUT	3.3V REGULATED OUT	
<input type="radio"/>	VU	5.0V USB OUT	
<input type="radio"/>	IF-		
<input type="radio"/>	IF+		
<input type="radio"/>	RD-	ETHERNET	
<input type="radio"/>	RD+	ETHERNET	
<input type="radio"/>	TD-	ETHERNET	
<input type="radio"/>	TD+	ETHERNET	
<input type="radio"/>	D-	USB	
<input type="radio"/>	D+	USB	
<input type="radio"/>	P30	CAN (RD)	
<input type="radio"/>	P29	CAN (TD)	
<input type="radio"/>	P28	SERIAL (TX)	I2C (SDA)
<input type="radio"/>	P27	SERIAL (RX)	I2C (SCL)
<input type="radio"/>	P26	PWMOUT	
<input type="radio"/>	P25	PWMOUT	
<input type="radio"/>	P24	PWMOUT	
<input type="radio"/>	P23	PWMOUT	
<input type="radio"/>	P22	PWMOUT	
<input type="radio"/>	P21	PWMOUT	

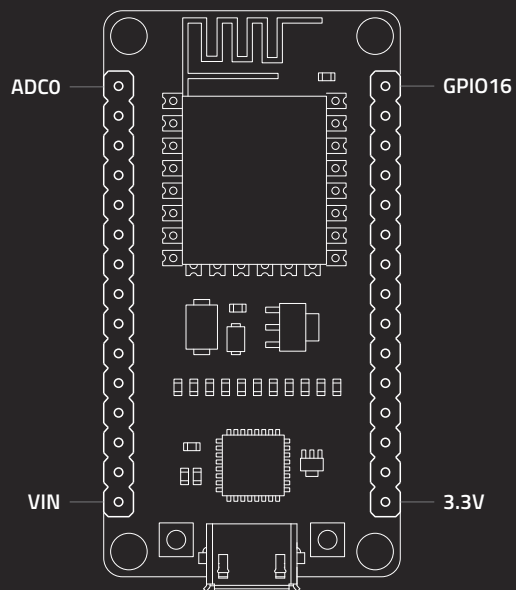



	NAME	
TOUT	ADCO	○
RESERVED		○
RESERVED		○
SDD3	GPIO10	○
SDD2	GPIO9	○
SDD1	MOSI	○
SDCMD	CS	○
SDD0	MISO	○
SDCLK	SCLK	○
GND		○
3.3V		○
EN		○
RST		○
GND		○
VIN		○

NAME		
GPIO16	USER	WAKE
GPIO5		
GPIO4		
GPIO0	FLASH	
GPIO2	TXD1	
3.3V		
GND		
GPIO14		HSCLK
GPIO12		HMISO
GPIO13	RXD2	HMOSI
GPIO15	TXD2	HCS
GPIO3	RXD0	
GPIO1	TXD0	
GND		
3.3V		

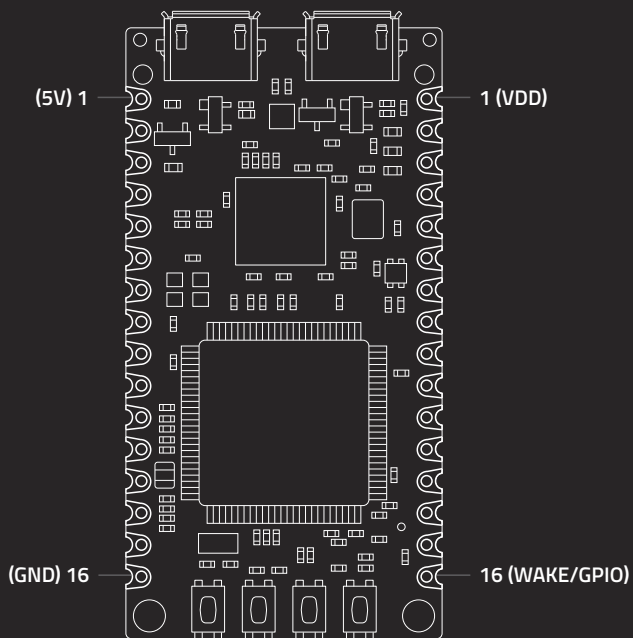

	NAME	#	
	5V	1	<input type="radio"/>
PIO0_16	ADCO_N	2	<input type="radio"/>
PIO0_23	ADCO_P	3	<input type="radio"/>
PIO0_15	GPIO	4	<input type="radio"/>
PIO1_5	GPIO	5	<input type="radio"/>
PIO1_8	GPIO	6	<input type="radio"/>
PIO1_9	GPIO	7	<input type="radio"/>
PIO1_10	GPIO	8	<input type="radio"/>
PIO0_14	FC1_SCL	9	<input type="radio"/>
PIO0_13	FC1_SDA	10	<input type="radio"/>
PIO0_27	FC2_TXD	11	<input type="radio"/>
PIO1_24	FC2_RXD	12	<input type="radio"/>
PIO1_31	PLU_INO	13	<input type="radio"/>
PIO0_0	COMP	14	<input type="radio"/>
	RESET ULP	15	<input type="radio"/>
	GND	16	<input type="radio"/>

#	NAME	
1	VDD	<input type="radio"/>
2	LED R	<input type="radio"/>
3	LED G	<input type="radio"/>
4	LED B	<input type="radio"/>
5	FC4_SCL	<input type="radio"/>
6	FC4_SDA	<input type="radio"/>
7	GPIO	<input type="radio"/>
8	GPIO	<input type="radio"/>
9	GPIO	<input type="radio"/>
10	SSEL1	<input type="radio"/>
11	SCK	<input type="radio"/>
12	MISO	<input type="radio"/>
13	MOSI	<input type="radio"/>
14	GPIO	<input type="radio"/>
15	GPIO	<input type="radio"/>
16	WAKE/GPIO	<input type="radio"/>

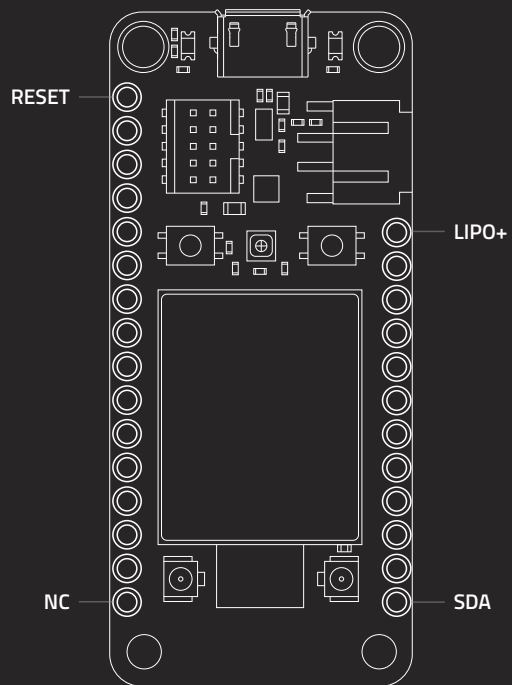



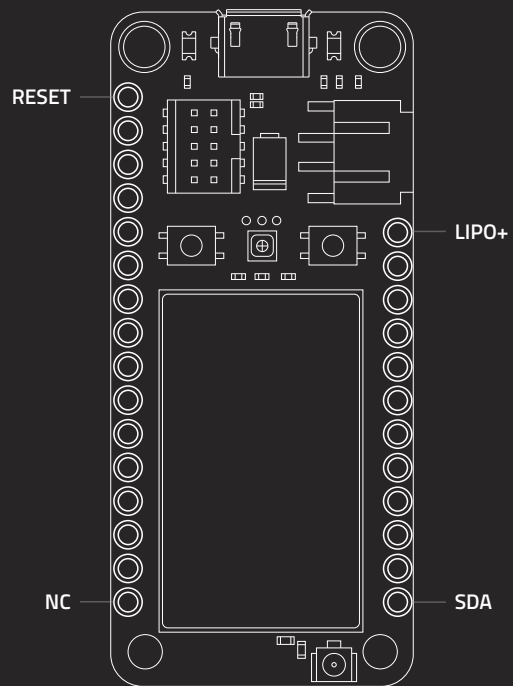



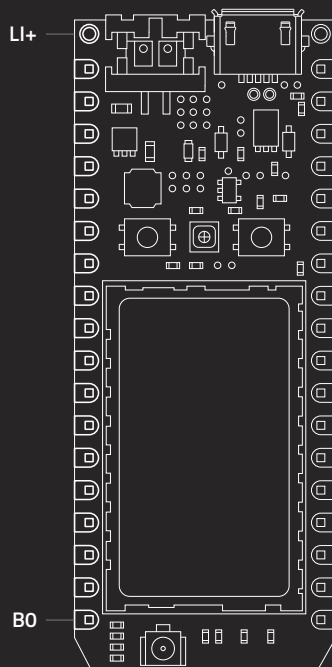



NAME				
LI+	LIPO+*			
VIN	VIN**			
GND				
TX	USART1_TX		PWM (TIM1_CH2)	PA9
RX	USART1_RX		PWM (TIM1_CH3)	PA10
A7	ADC0		PWM (TIM5_CH1)	PA0
A6	ADC4		DAC1	PA4
A5	ADC7	SPI (MOSI)	PWM (TIM3_CH2)	PA7
A4	ADC6	SPI (MISO)	PWM (TIM3_CH1)	PA6
A3	ADC5	SPI (SCK)	DAC2	PA5
A2	ADC12	SPI (SS)		PC2
A1	ADC13			PC3
A0	ADC15			PC5
B5	ADC11			PC1
B4	ADC10			PC0
B3	ADC9		PWM (TIM3_CH4)	PB1
B2	ADC8		PWM (TIM3_CH3)	PB0
B1			PWM (TIM8_CH1)	PC6
B0			PWM (TIM8_CH3)	PC8

\*Connected to the positive terminal of the LiPo battery \*\*3.9VDC to 12VDC Input

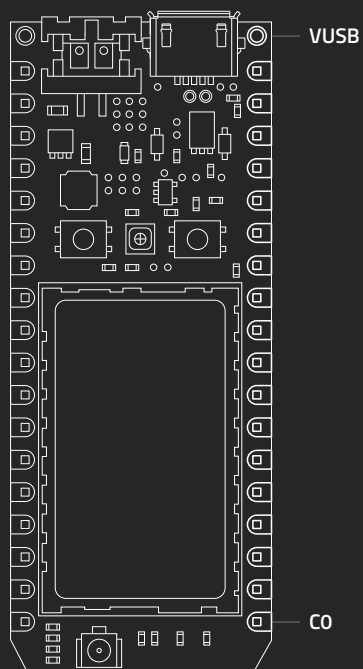

	NAME					
⊙	VUSB	VUSB*				
□	3V3	3V3**				
□	RST	RESET				NRST
□	VBAT	VBAT***				VBAT
□	GND					
□	D7	JTAG_TMS				PA13
□	D6	JTAG_TCK				PA14
□	D5	JTAG_TDI	SPI1 / SPI2 (SS)		I2S3_WS	PA15
□	D4	JTAG_TDO	SPI1 (SCK)		I2S3_SCK	PB3
□	D3	JTAG_TRST	SPI1 (MISO)		PWM (TIM3_CH1)	PB4
□	D2		SPI1 (MOSI)	CAN2_RX	PWM (TIM3_CH2)	I2S3_SD
□	D1	SCL		CAN2_TX	PWM (TIM4_CH1)	PB6
□	D0	SDA			PWM (TIM4_CH2)	PB7
□	C5	SCL		CAN1_RX	PWM (TIM4_CH3)	PB8
□	C4	SDA		CAN1_TX	PWM (TIM4_CH4)	PB9
□	C3	UART4_TX	SPI2 (SCK)			PC10
□	C2	UART4_RX	SPI2 (MISO)			PC11
□	C1	UART5_TX	SPI2 (MOSI)			PC12
□	C0	UART5_RX				PD2

\*Connected to USB VCC (+5v Typical) \*\*3v3DC/800mA max output \*\*\*Internally jumpered to 3V3

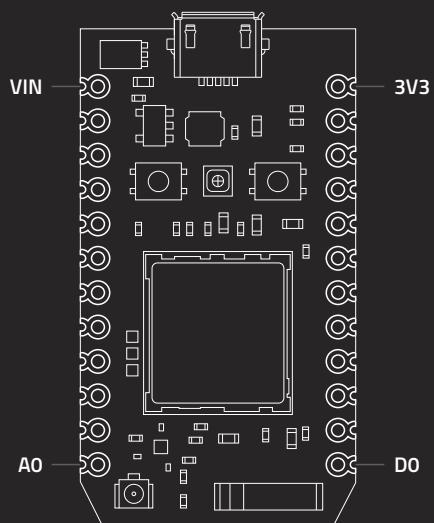

NAME	FUNCTIONS			STM32
VIN	VIN*			
GND	GND			
TX		USART1_TX	PWM (TIM1_CH2)	PA9
RX		USART1_RX	PWM (TIM1_CH3)	PA10
WKP	ADC0		PWM (TIM5_CH1)	PA0
DAC	ADC4		DAC1	PA4
A5	ADC7	SPI (MOSI)		PA7
A4	ADC6	SPI (MISO)		PA6
A3	ADC5	SPI (SCK)		PA5
A2	ADC12	SPI (SS)		PC2
A1	ADC13			PC3
A0	ADC15			PC5

NAME	FUNCTIONS			STM32
3V3	3V3**			
RST	RESET			E8
VBAT	VBAT***			A9
GND	GND			
D7	JTAG_TMS			PA13
D6	JTAG_TCK			PA14
D5	JTAG_TDI	SPI1 (SS)		PA15
D4	JTAG_TDO	SPI1 (SCK)		PB3
D3	JTAG_TRST	SPI1 (MISO)		PB4
D2		SPI1 (MOSI)	CAN2_RX	PB5
D1	SCL		CAN2_TX	PB6
D0	SDA		PWM (TIM4_CH2)	PB7

\*Pin can be used as input or output. As input, supply 3.6 - 5.5VDC. When the Photon is powered by USB, this pin outputs ~4.8VDC at max 1A load. \*\*3.3VDC regulated output at max 100mA load. Can also be used to power the Photon instead of VIN / USB. \*\*\*Supply to the internal RTC, backup registers and SRAM when 3V3 is not present (1.65 to 3.6VDC).

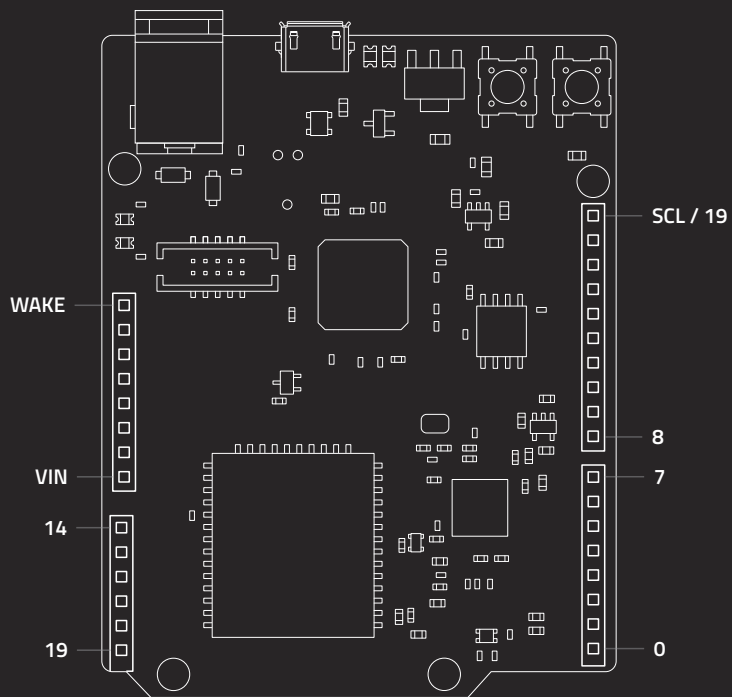

	NAME
<input type="checkbox"/>	DIGITAL WAKE
<input type="checkbox"/>	IOREF = 3.3V
<input type="checkbox"/>	RESET
<input type="checkbox"/>	3.3V OUT
<input type="checkbox"/>	5V OUT
<input type="checkbox"/>	GND
<input type="checkbox"/>	GND
<input type="checkbox"/>	VIN (7-12V)

	NAME	FUNCTIONS				
<input type="checkbox"/>	14	NO CONNECT				
<input type="checkbox"/>	15	GPIO 9	INT 9			SPI
<input type="checkbox"/>	16	GPIO 10	INT 10	PWM		SPI
<input type="checkbox"/>	17	GPIO 11	INT 11	PWM		
<input type="checkbox"/>	18	GPIO 12	INT 12	PWM	I2C	
<input type="checkbox"/>	19	GPIO 13	INT 13	PWM	I2C	

FUNCTIONS					NAME
	I2C	PWM	INT 21	GPIO 13	SCL / 19
	I2C	PWM	INT 20	GPIO 12	SDA / 18
NO CONNECT					AREF
GROUND					GND
SPI			INT 13	GPIO 5	13
SPI			INT 12	GPIO 4	12
SPI		PWM	INT 11	GPIO 3	11
SPI		PWM	INT 10	GPIO 2	10
		PWM	INT 9	GPIO 1	9
		PWM			8

FUNCTIONS					NAME
SERIAL			INT 31	GPIO 23	7
		PWM	INT 30	GPIO 22	6
		PWM	INT 29	GPIO 21	5
		PWM	INT 28	GPIO 20	4
		PWM	INT 27	GPIO 19	3
SERIAL			INT 26	GPIO 18	2
SERIAL			INT 25	GPIO 17	TX0>1
SERIAL			INT 24	GPIO 16	RX<0

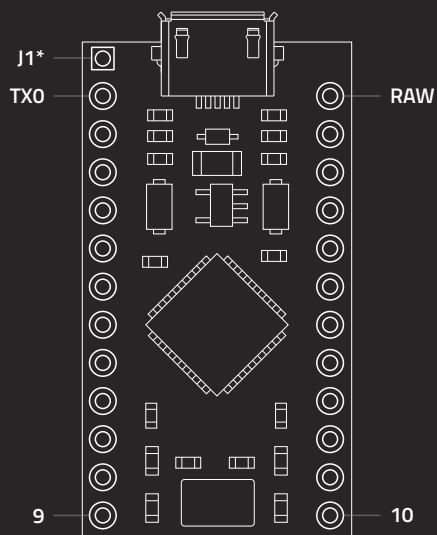



	NAME	FUNCTIONS						
⊙	TX0	D1	PD3	TX1	INT3			
⊙	RXI	D0	PD2	RX1	INT2			
⊙	GND	GND						
⊙	GND	GND						
⊙	2	D2	PD1	SDA	INT1			
⊙	3	D3	PD0	8-BIT	SCL	INT0	OC0B	
⊙	4	D4/A6	PD4	ADC8	ICP1			
⊙	5	D5	PC6	10-BIT	OC3A	OCA4		
⊙	6	D6/A7	PD7	ADC10	10-BIT	OC4D	TO	
⊙	7	D7	PE6	INT6	AIN0			
⊙	8	D8/A8	PB4	ADC11	PCINT4			
⊙	9	D9/A9	PB5	ADC12	16-BIT	PCINT5	OC1A	OC4B

	NAME	FUNCTIONS						
⊙	RAW	RAW						
⊙	GND	GND						
⊙	RST	RESET						
⊙	VCC	VCC						
⊙	A3	A3	PF4	ADC4	TCK			
⊙	A2	A2	PF5	ADC5	TMS			
⊙	A1	A1	PF6	ADC6	TDO			
⊙	A0	A0	PF7	ADC7	TDI			
⊙	15	D15	PB1	SCK	PCINT1			
⊙	14	D14	PB3	MISO	PCINT3	PD0		
⊙	16	D16	PB2	MOSI	PCINT2	PDI		
⊙	10	D10/A10	PB6	ADC13	16-BIT	PCINT6	OC1B	OC4B

\*J1 Connects to VCC to USB (bypassing the regulator)

Power: Raw: 6-16V. VCC: 5V at 500mA

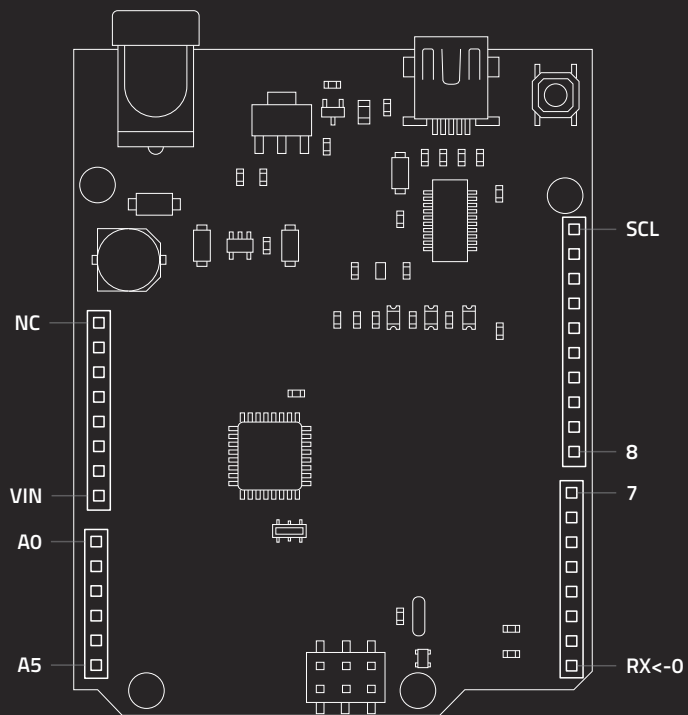

- 
- 
- 
- 
- 
- 
- 
- 

NAME		FUNCTIONS			
NC	NC				
IOREF	IOREF				
RST	RESET	PC6	PCINT14		
3.3V	3.3V				
5V	5V				
GND	GND				
GND	GND				
VIN	VIN				

- 
- 
- 
- 
- 
- 
- 

NAME		FUNCTIONS				
A0	A0/D14	PC0	ADC0	PCINT8		
A1	A1/D15	PC1	ADC1	PCINT9		
A2	A2/D16	PC2	ADC2	PCINT10		
A3	A3/D17	PC3	ADC3	PCINT11		
A4	A4/D18	PC4	ADC4	SDA	PCINT12	
A5	A5/D19	PC5	ADC5	SCL	PCINT13	

Power: VIN: 7-15V. VCC: 5V. Max Current: 800mA on 5V; 150mA on 3.3v

FUNCTIONS						NAME
	PCINT13	SCL	ADC5	PC5	A5/D19	SCL
	PCINT12	SDA	ADC4	PC4	A4/D18	SDA
					AREF	AREF
					GND	GND
	LED	PCINT5	SCK	PB5	D13	13
		PCINT4	MISO	PB4	D12	12
OC2A	PCINT3	MOSI	8-BIT	PB3	D11	11
OC1B	PCINT2	SS	8-BIT	PB2	D10	10
	OC1A	PCINT1	8-BIT	PB1	D9	9
	CLKO	ICP1	PCINT0	PB0	D8	8

- 
- 
- 
- 
- 
- 
- 
- 
- 
- 

FUNCTIONS						NAME
		IN1	PCINT23	PD7	D7	7
AIN0	OC0A	PCINT22	8-BIT	PD6	D6	6
T1	OC0B	PCINT21	8-BIT	PD5	D5	5
	XCK	T0	PCINT20	PD4	D4	4
OC2B	PCINT19	INT1	8-BIT	PD3	D3	3
		PCINT18	INT0	PD2	D2	2
		PCINT17	TXD	PD1	D1	TX0>1
		PCINT16	RXD	PD0	D0	RX<0

- 
- 
- 
- 
- 
- 
- 
-

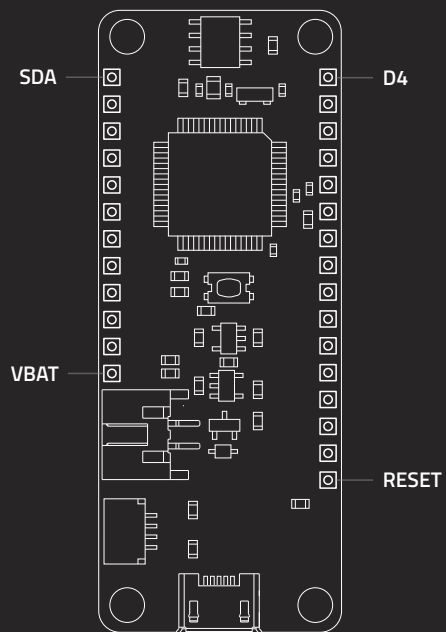

FUNCTIONS					NAME
3:0/5:1	SDA	INT6	PA22	D20	SDA
3:1/5:0	SCL	INT7	PA23	D21	SCL
	2:3/4:3	INT15	PA15	D5	D5
	5:2/3:2	INT4	PA20	D6	D6
0:3	INT7	AIN7	PA07	D9	D9
	1:2/3:2	INT2	PA18	D10	D10
	1:0/3:1	INT0	PA16	D11	D11
	1:3/3:3	INT3	PA19	D12	D12
LED	1:1/3:0	INT1	PA17	D13	D13
				VUSB	VUSB
				VREG	EN
				VBAT	VBAT



NAME	FUNCTIONS					
D4	D4	PA06	AIN6	INT6	0:2	VREFC
D1	D1	PA12	INT12	RX	2:0/4:1	
D0	D0	PA13	INT13	TX	2:1/4:0	
MISO	D22	PA11	INT11	MISO	4:3	
MOSI	D23	PB12	INT12	MOSI	4:0	
SCK	D24	PB13	INT13	SCK	4:1	
A5	A5	PB02	AIN14	INT2	5:0	
A4	A4	PA05	AIN5	INT5	0:1	DAC1
A3	A3	PA04	AIN4	INT4	0:0	VREFB
A2	A2	PB09	AIN3	INT9	4:1	
A1	A1	PB08	AIN2	INT8	4:0	
A0	A0	PA02	AIN0	INT2	DAC0	
GND	GND					
NC	NC					
3.3V	3.3V					
RESET	RST					

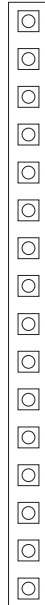

Power: Vin: 2.5 - 6V. VCC: 3.3V @ 600mA. JST: Single Cell LiPo  
 Battery charging via USB.

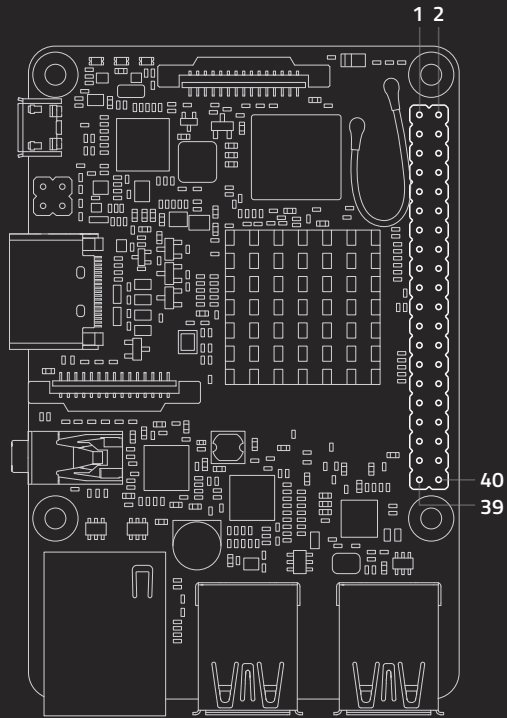



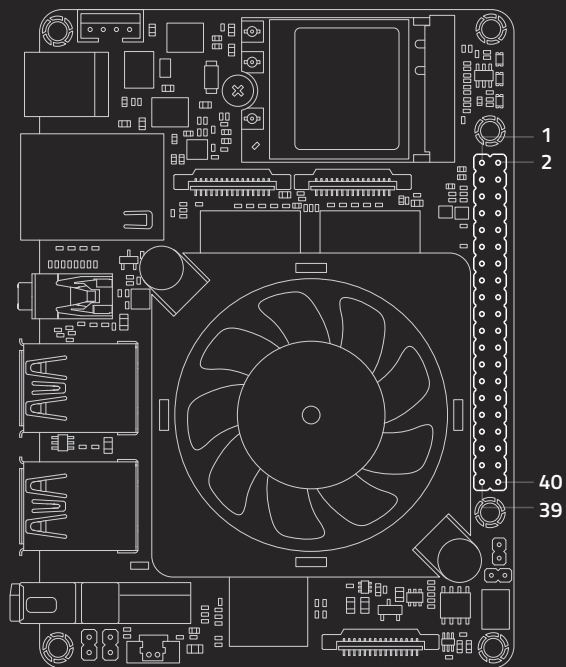



NAME	#			#	NAME
VCC3.3V_IO	1	□	○	2	VCC5V
GPIO2_B1/I2C6_SDA	3	○	○	4	VCC5V
GPIO2_B2/I2C6_SCL	5	○	○	6	GND
GPIO2_D1_CLKOUT	7	○	○	8	GPIO2_C1/UART0_TX
GND	9	○	○	10	GPIO2_C0/UART0_RX
GPIO2_C3/UART0_RTSN	11	○	○	12	GPIO3_D0/I2S0_SCLK
GPIO2_C5/SPI5_TXD	13	○	○	14	GND
GPIO2_C4/SPI5_RXD	15	○	○	16	GPIO2_C6/SPI5_CLK
VCC3.3_IO	17	○	○	18	GPIO2_C7/SPI5_CSNO
GPIO1_B0/SPI1_TXD/UART4_TX	19	○	○	20	GND
GPIO1_A7/SPI1_RXD/UART4_RX	21	○	○	22	GPIO3_D4/I2S0_SDI5DO3
GPIO1_B1/SPI1_CLK	23	○	○	24	GPIO1_B2/SPI1_CSNO
GND	25	○	○	26	GPIO0_A6/PWM3A_IR
GPIO2_A7/I2C7_SDA	27	○	○	28	GPIO2_B0/I2C7_SCL
GPIO3_D6/I2S0_SDI3SDO1	29	○	○	30	GND
GPIO3_D5/I2S0_SDI2SDO2	31	○	○	32	GPIO4_C2/PWM0
GPIO4_C6/PWM1	33	○	○	34	GND
GPIO3_D1/1S20_LRCK	35	○	○	36	GPIO2_C2/UART0_CTSN
GPIO4_C5/SPDIF_TX	37	○	○	38	GPIO3_D3/I2S0_SDI0
GND	39	○	○	40	GPIO3_D7/I2S0_SD00

NOTE: In addition to no. 32, 33, 37 pins, all the others are +3.3V level, 5K~10K Ohm internal pull-up resistors, 50mA drive current capacity.

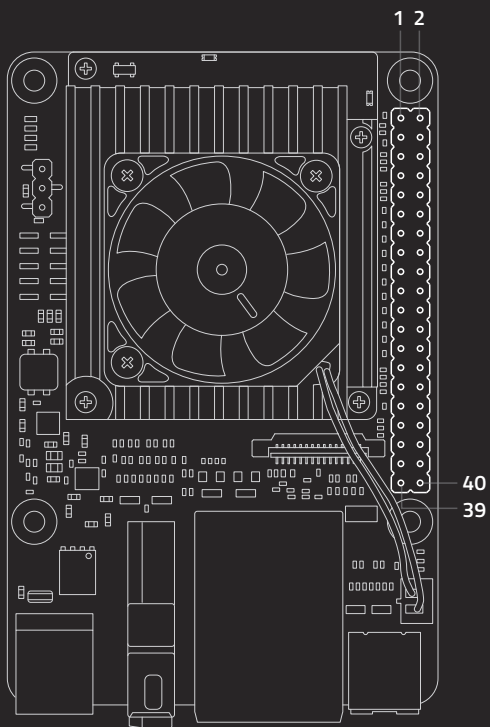

SYSFS PATH	NAME	#			#	NAME	SYSFS PATH
	VCC3.3V_IO	1	□	○	2	VCC5V	
/dev/i2c-1	GPIO145_I2C2_SDA	3	○	○	4	VCC5V	
/dev/i2c-1	GPIO144_I2C2_SCL	5	○	○	6	GND	
/dev/ttymx2	GPIO155_UART3_TXD	7	○	○	8	GPIO151_UART1_TXD	/dev/ttymx0
	GND	9	○	○	10	GPIO150_UART1_RXD	/dev/ttymx0
/dev/ttymx2	GPIO154_UART3_RXD	11	○	○	12	GPIO107_SAI1_TXC	
/sys/class/gpio/gpio6	GPIO6	13	○	○	14	GND	
/sys/class/pwm/pwmchip2/pwm0	GPIO130_PWM4	15	○	○	16	GPIO73	/sys/class/gpio/gpio73
	VCC3.3V_IO	17	○	○	18	GPIO138	/sys/class/gpio/gpio138
/dev/spidev32766	GPIO135_ECSP11_MOSI	19	○	○	20	GND	
/dev/spidev32766	GPIO136_ECSP11_MISO	21	○	○	22	GPIO140	/sys/class/gpio/gpio140
/dev/spidev32766	GPIO134_ECSP11_SCLK	23	○	○	24	GPIO137_ECSP11_SSO	/dev/spidev32766.0
	GND	25	○	○	26	GPIO66_ECSP11_SS1	/dev/spidev32766.1
/dev/i2c-2	GPIO147_I2C3_SDA	27	○	○	28	GPIO146_I2C3_SCL	/dev/i2c-2
/sys/class/gpio/gpio7	GPIO7	29	○	○	30	GND	
/sys/class/gpio/gpio8	GPIO8	31	○	○	32	GPIO1_PWM1	/sys/class/pwm/pwmchip0/pwm0
/sys/class/pwm/pwmchip1/pwm0	GPIO13_PWM2	33	○	○	34	GND	
	GPIO106_SAI1_TXFS	35	○	○	36	GPIO141	/sys/class/gpio/gpio141
/sys/class/gpio/gpio77	GPIO77	37	○	○	38	GPIO98_SAI1_RXD0	
	GND	39	○	○	40	GPIO108_SAI_TXD0	

NOTE: All I/O pins have a 90k pull-down resistor inside the iMX8M SoC that is used by default during bootup, except for the I2C pins, which instead have a pull-up to 3.3V on the SoM. Do not connect a device that draws more than ~ 82 mA of power or you will brownout the system.

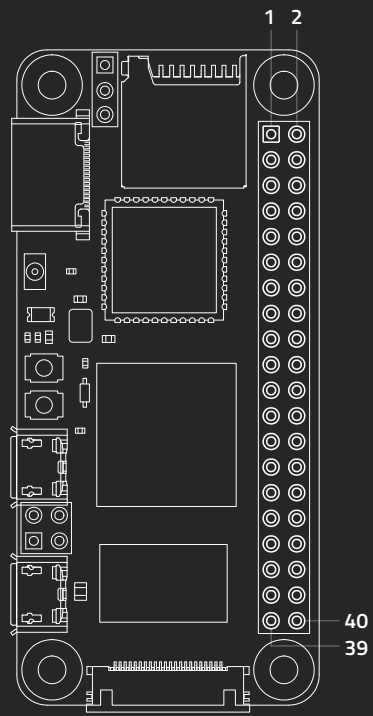

WIRING PI #	MAIN FUNCTIONS	#			#	MAIN FUNCTIONS	WIRING PI #
	3V3 POWER	1	<input type="checkbox"/>	<input type="radio"/>	2	5V POWER	
8	GPIO2 (I2C1 SDA)	3	<input type="radio"/>	<input type="radio"/>	4	5V POWER	
9	GPIO3 (I2C1 SCL)	5	<input type="radio"/>	<input type="radio"/>	6	GROUND	
7	GPIO4 (GPCLK0)	7	<input type="radio"/>	<input type="radio"/>	8	GPIO14 (UART TX)	15
	GROUND	9	<input type="radio"/>	<input type="radio"/>	10	GPIO15 (UART RX)	16
0	GPIO17	11	<input type="radio"/>	<input type="radio"/>	12	GPIO18 (PCM CLK)	1
2	GPIO27	13	<input type="radio"/>	<input type="radio"/>	14	GROUND	
3	GPIO22	15	<input type="radio"/>	<input type="radio"/>	16	GPIO23	4
	3V3 POWER	17	<input type="radio"/>	<input type="radio"/>	18	GPIO24	5
12	GPIO10 (SPI0 MOSI)	19	<input type="radio"/>	<input type="radio"/>	20	GROUND	
13	GPIO9 (SPI0 MISO)	21	<input type="radio"/>	<input type="radio"/>	22	GPIO25	6
14	GPIO11 (SPI0 SCLK)	23	<input type="radio"/>	<input type="radio"/>	24	GPIO8 (SPI0 CE0)	10
	GROUND	25	<input type="radio"/>	<input type="radio"/>	26	GPIO7 (SPI0 CE1)	11
30	GPIO0 (EEPROM SDA)	27	<input type="radio"/>	<input type="radio"/>	28	GPIO1 (EEPROM SCL)	31
21	BCM 5	29	<input type="radio"/>	<input type="radio"/>	30	GROUND	
22	BCM 6	31	<input type="radio"/>	<input type="radio"/>	32	GPIO12 (PWM0)	26
23	GPIO13 (PWM1)	33	<input type="radio"/>	<input type="radio"/>	34	GROUND	
24	GPIO19 (PCM FS)	35	<input type="radio"/>	<input type="radio"/>	36	GPIO16	27
25	GPIO26	37	<input type="radio"/>	<input type="radio"/>	38	GPIO20 (PCM DIN)	28
	GROUND	39	<input type="radio"/>	<input type="radio"/>	40	GPIO21 (PCM DOUT)	29

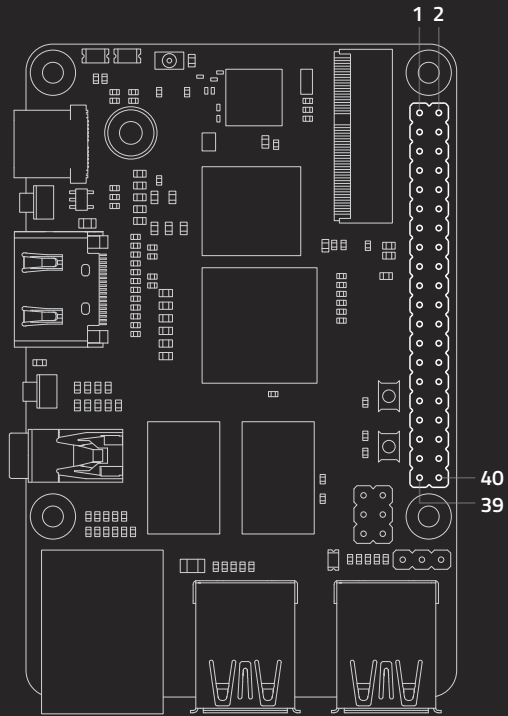



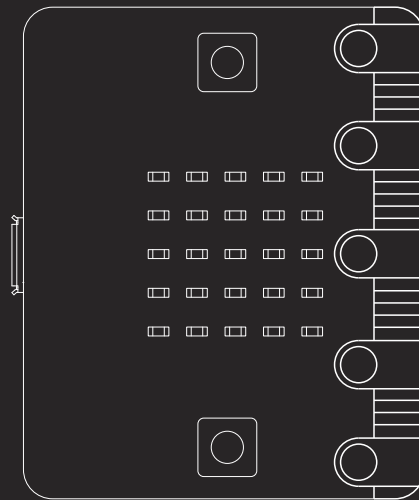



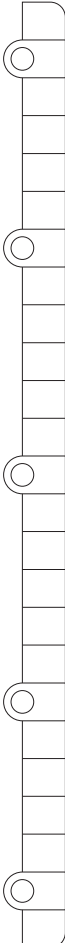

NAME	MAIN FUNCTION	ALT FUNCTIONS
GND	GROUND	
GND	GROUND	
GND	GROUND	
P20	I2C (SDA)	GPIO, PWM, UART
P19	I2C (SCL)	GPIO, PWM, UART
+3V3	3V POWER SUPPLY (MAX 90mA).	
+3V3	3V POWER SUPPLY (MAX 90mA).	
+3V3	3V POWER SUPPLY (MAX 90mA).	
P16	GPIO	PWM, UART
P15	GPIO	SPI (MOSI), PWM, UART
P14	GPIO	SPI (MISO), PWM, UART
P13	GPIO	SPI (SCLK), PWM, UART
P2	GPIO	ANALOG, TOUCH, PWM, UART
P12	RESERVED FOR ACCESSIBILITY	GPIO, PWM, UART
P11	BUTTON (B)	GPIO, PWM, UART
P10	LED MATRIX COLUMN 3	GPIO, ANALOG, PWM, UART
P9	LED MATRIX COLUMN 7	GPIO, PWM, UART
P8	GPIO	PWM, UART
P1	GPIO	ANALOG, TOUCH, PWM, UART
P7	LED MATRIX COLUMN 8	GPIO, PWM, UART
P6	LED MATRIX COLUMN 9	GPIO, PWM, UART
P5	BUTTON (A)	GPIO, PWM, UART
P4	LED MATRIX COLUMN 2	GPIO, ANALOG, PWM, UART
P0	GPIO	ANALOG, TOUCH, PWM, UART
P3	LED MATRIX COLUMN 1	GPIO, ANALOG, PWM, UART

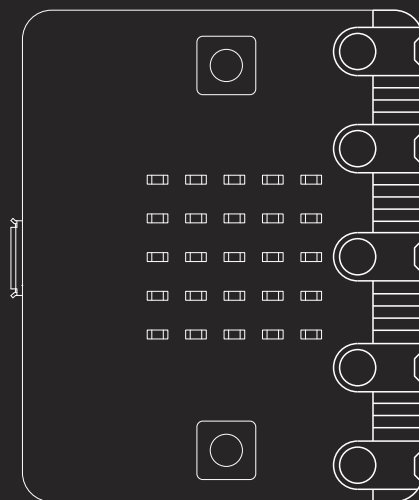

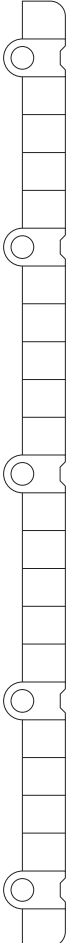

NAME	MAIN FUNCTION	ALT FUNCTIONS
GND	GROUND	
GND	GROUND	
GND	GROUND	
P20	I2C (SDA)	GPIO, PWM, UART
P19	I2C (SCL)	GPIO, PWM, UART
+3V3	3V POWER SUPPLY (MAX 90mA).	
+3V3	3V POWER SUPPLY (MAX 90mA).	
+3V3	3V POWER SUPPLY (MAX 90mA).	
P16	GPIO	PWM, UART
P15	GPIO	SPI (MOSI), PWM, UART
P14	GPIO	SPI (MISO), PWM, UART
P13	GPIO	SPI (SCLK), PWM, UART
P2	GPIO	ANALOG, TOUCH, PWM, UART
P12	RESERVED FOR ACCESSIBILITY	GPIO, PWM, UART
P11	BUTTON (B)	GPIO, PWM, UART
P10	LED MATRIX COLUMN 5	GPIO, ANALOG, PWM, UART
P9		GPIO, PWM, UART, NFC1
P8	GPIO	PWM, UART, NFC2
P1	GPIO	ANALOG, TOUCH, PWM, UART
P7	LED MATRIX COLUMN 2	GPIO, PWM, UART
P6	LED MATRIX COLUMN 4	GPIO, PWM, UART
P5	BUTTON (A)	GPIO, PWM, UART
P4	LED MATRIX COLUMN 1	GPIO, ANALOG, PWM, UART
P0	GPIO	ANALOG, TOUCH, PWM, UART
P3	LED MATRIX COLUMN 3	GPIO, ANALOG, PWM, UART

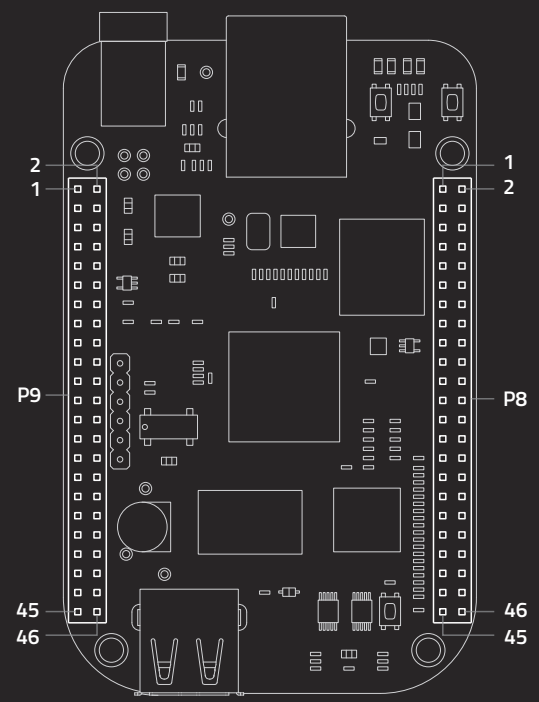

NAME	#	P9		#	NAME	NAME	#	P8		#	NAME
GND	1	<input type="checkbox"/>	<input type="checkbox"/>	2	GND	GND	1	<input type="checkbox"/>	<input type="checkbox"/>	2	GND
DC_3.3V	3	<input type="checkbox"/>	<input type="checkbox"/>	4	DC_3.3V	GPIO1_6	3	<input type="checkbox"/>	<input type="checkbox"/>	4	GPIO1_7
VDD_5V	5	<input type="checkbox"/>	<input type="checkbox"/>	6	VDD_5V	GPIO1_2	5	<input type="checkbox"/>	<input type="checkbox"/>	6	GPIO1_3
SYS_5V	7	<input type="checkbox"/>	<input type="checkbox"/>	8	SYS_5V	TIMER4	7	<input type="checkbox"/>	<input type="checkbox"/>	8	TIMER7
PWR_BUT	9	<input type="checkbox"/>	<input type="checkbox"/>	10	SYS_RESETN	TIMER5	9	<input type="checkbox"/>	<input type="checkbox"/>	10	TIMER6
UART4_RXD	11	<input type="checkbox"/>	<input type="checkbox"/>	12	GPIO1_28	GPIO1_13	11	<input type="checkbox"/>	<input type="checkbox"/>	12	GPIO1_12
UART4_TXD	13	<input type="checkbox"/>	<input type="checkbox"/>	14	EHRPWM1A	EHRPWM2B	13	<input type="checkbox"/>	<input type="checkbox"/>	14	GPIO0_26
GPIO1_16	15	<input type="checkbox"/>	<input type="checkbox"/>	16	EHRPWM1B	GPIO1_15	15	<input type="checkbox"/>	<input type="checkbox"/>	16	GPIO1_14
I2C1_SCL	17	<input type="checkbox"/>	<input type="checkbox"/>	18	I2C1_SDA	GPIO0_27	17	<input type="checkbox"/>	<input type="checkbox"/>	18	GPIO2_1
I2C2_SCL	19	<input type="checkbox"/>	<input type="checkbox"/>	20	I2C2_SDA	EHRPWM2A	19	<input type="checkbox"/>	<input type="checkbox"/>	20	GPIO1_31
UART2_TXD	21	<input type="checkbox"/>	<input type="checkbox"/>	22	UART2_RXD	GPIO1_30	21	<input type="checkbox"/>	<input type="checkbox"/>	22	GPIO1_5
GPIO1_17	23	<input type="checkbox"/>	<input type="checkbox"/>	24	UART1_TXD	GPIO1_4	23	<input type="checkbox"/>	<input type="checkbox"/>	24	GPIO1_1
GPIO3_21	25	<input type="checkbox"/>	<input type="checkbox"/>	26	UART1_RXD	GPIO1_0	25	<input type="checkbox"/>	<input type="checkbox"/>	26	GPIO1_29
GPIO3_19	27	<input type="checkbox"/>	<input type="checkbox"/>	28	SPI1_CS0	GPIO2_22	27	<input type="checkbox"/>	<input type="checkbox"/>	28	GPIO2_24
SPI1_D0	29	<input type="checkbox"/>	<input type="checkbox"/>	30	SPI1_D1	GPIO2_23	29	<input type="checkbox"/>	<input type="checkbox"/>	30	GPIO2_25
SPI1_SCLK	31	<input type="checkbox"/>	<input type="checkbox"/>	32	VADC	UART5_CTSN	31	<input type="checkbox"/>	<input type="checkbox"/>	32	UART5_RTSN
AIN4	33	<input type="checkbox"/>	<input type="checkbox"/>	34	AGND	UART4_RTSN	33	<input type="checkbox"/>	<input type="checkbox"/>	34	UART3_RTSN
AIN6	35	<input type="checkbox"/>	<input type="checkbox"/>	36	AIN5	UART4_CTSN	35	<input type="checkbox"/>	<input type="checkbox"/>	36	UART3_CTSN
AIN2	37	<input type="checkbox"/>	<input type="checkbox"/>	38	AIN3	UART5_TXD	37	<input type="checkbox"/>	<input type="checkbox"/>	38	UART5_RXD
AIN0	39	<input type="checkbox"/>	<input type="checkbox"/>	40	AIN1	GPIO2_12	39	<input type="checkbox"/>	<input type="checkbox"/>	40	GPIO2_13
CLKOUT2	41	<input type="checkbox"/>	<input type="checkbox"/>	42	GPIO0_7	GPIO2_10	41	<input type="checkbox"/>	<input type="checkbox"/>	42	GPIO2_11
GND	43	<input type="checkbox"/>	<input type="checkbox"/>	44	GND	GPIO2_8	43	<input type="checkbox"/>	<input type="checkbox"/>	44	GPIO2_9
GND	45	<input type="checkbox"/>	<input type="checkbox"/>	46	GND	GPIO2_6	45	<input type="checkbox"/>	<input type="checkbox"/>	46	GPIO2_7

NOTE: More pin modes are available in the datasheet

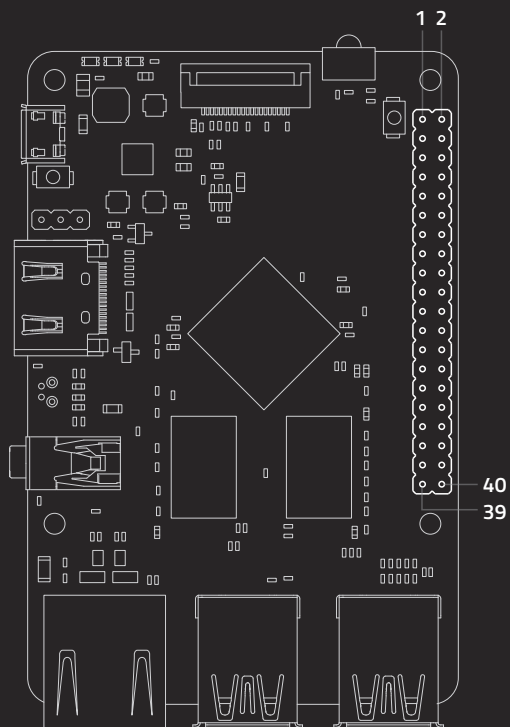

LINUX #	NAME	#			#	NAME	LINUX #
	VCC3V3-OUT	1	<input type="checkbox"/>	<input type="radio"/>	2	VCC5V	
12	TWI0-SDA	3	<input type="radio"/>	<input type="radio"/>	4	VCC5V	
11	TWI0-SCK	5	<input type="radio"/>	<input type="radio"/>	6	GND	
2	CPUX-TDO	7	<input type="radio"/>	<input type="radio"/>	8	AP-UART1-TX	198
	GND	9	<input type="radio"/>	<input type="radio"/>	10	AP-UART1-RX	199
1	CPUX-TCK	11	<input type="radio"/>	<input type="radio"/>	12	BB-PCM-CLK	203
0	CPUX-TMS	13	<input type="radio"/>	<input type="radio"/>	14	GND	
3	CPUX-TDI	15	<input type="radio"/>	<input type="radio"/>	16	AP-UART1-CTS	201
	VCC3V3-OUT	17	<input type="radio"/>	<input type="radio"/>	18	AP-UART1-RTS	200
64	SPI0-MOSI	19	<input type="radio"/>	<input type="radio"/>	20	GND	
65	SPI0-MISO	21	<input type="radio"/>	<input type="radio"/>	22	UART3-RX	14
66	SPI0-CLK	23	<input type="radio"/>	<input type="radio"/>	24	SPI0-CS	67
	GND	25	<input type="radio"/>	<input type="radio"/>	26	SPDIF	17
19	I2S0-SCLK	27	<input type="radio"/>	<input type="radio"/>	28	I2S0-LRCK	18
20	I2S0-SDO	29	<input type="radio"/>	<input type="radio"/>	30	GND	
21	I2S0-SDI	31	<input type="radio"/>	<input type="radio"/>	32	UART3-TX	13
6	PWM1	33	<input type="radio"/>	<input type="radio"/>	34	GND	15
202	BB-PCM-SYNC	35	<input type="radio"/>	<input type="radio"/>	36	UART3-RTS	
16	UART3-CTS	37	<input type="radio"/>	<input type="radio"/>	38	BB-PCM-DIN	205
	GND	39	<input type="radio"/>	<input type="radio"/>	40	BB-PCM-DOUT	204

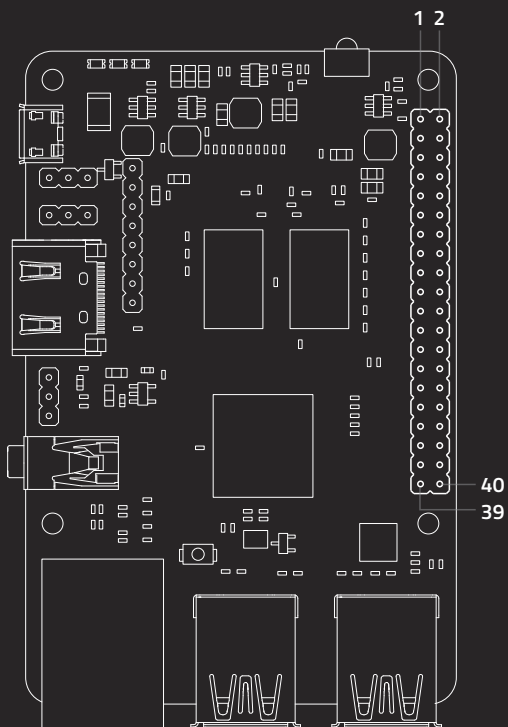



SYSFS	LINUX #	NAME	#			#	NAME	LINUX #	SYSFS
		VCC3.3V	1	<input type="checkbox"/>	<input type="radio"/>	2	VCC5V		
5	5	I2C_SDA_AO	3	<input type="radio"/>	<input type="radio"/>	4	VCC5V		
4	4	I2C_SCK_AO	5	<input type="radio"/>	<input type="radio"/>	6	GND		
2	98	GPIOCLK_0	7	<input type="radio"/>	<input type="radio"/>	8	UART_A_TX	91	101
		GND	9	<input type="radio"/>	<input type="radio"/>	10	UART_A_RX	92	102
8	8*	I2SOUT-CH23	11	<input type="radio"/>	<input type="radio"/>	12	PWM_F	6	6
9	9	I2SOUT-CH45	13	<input type="radio"/>	<input type="radio"/>	14	GND		
10	10*	I2SOUT-CH67	15	<input type="radio"/>	<input type="radio"/>	16	UART_A_CTS_N	93	103
		VCC3.3V	17	<input type="radio"/>	<input type="radio"/>	18	UART_A_RTS_N	94	104
97	87	BTPCM_DOUT	19	<input type="radio"/>	<input type="radio"/>	20	GND		
98	88	BTPCM_DIN	21	<input type="radio"/>	<input type="radio"/>	22	WIFI_SD_D0	79	89
100	90	BTPCM_CLK	23	<input type="radio"/>	<input type="radio"/>	24	BTPCM_SYNC	89	99
		GND	25	<input type="radio"/>	<input type="radio"/>	26	WIFI_SD_D1	80	90
85	75	I2C_SDA_A	27	<input type="radio"/>	<input type="radio"/>	28	I2C_SCK_A	76	86
106	96	BT_EN	29	<input type="radio"/>	<input type="radio"/>	30	GND		
107	97	BT_WAKE_HOST	31	<input type="radio"/>	<input type="radio"/>	32	WIFI_32K	95	105
95	85	WIFI_PWREN	33	<input type="radio"/>	<input type="radio"/>	34	GND		
96	86	WIFI_WAKE_HOST	35	<input type="radio"/>	<input type="radio"/>	36	WIFI_SD_D2	81	91
94	94	WIFI_SD_CMD	37	<input type="radio"/>	<input type="radio"/>	38	WIFI_SD_D3	82	92
		GND	39	<input type="radio"/>	<input type="radio"/>	40	WIFI_SD_CLK	83	93

\* Requires 211 jumper to be positioned to pass GPIOAO\_8 to 40 pin header

\*\* Requires Linux kernel 4.19+ to set direction to output

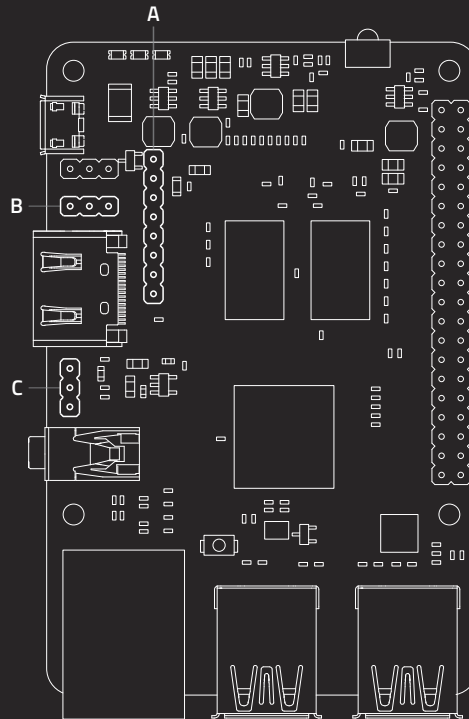

A	#	NAME	LINUX #	SYSFS
<input type="checkbox"/>	1	ADC0		
<input type="radio"/>	2	ADC2		
<input type="radio"/>	3	I2SOUT-CH01	25	35
<input type="radio"/>	4	I2S-LR-CLK	24	34
<input type="radio"/>	5	I2S-AO-CLK	23	33
<input type="radio"/>	6	I2S-AM-CLK	22	32
<input type="radio"/>	7	GND		
<input type="radio"/>	8	VDDIO_A03.3V		

B	#	NAME	LINUX #	SYSFS
<input type="checkbox"/>	1	GND		
<input type="radio"/>	2	LINUX_TX	0	0
<input type="radio"/>	3	LINUX_RX	1	1

C	#	NAME	LINUX #	SYSFS
<input type="checkbox"/>	1	GND		
<input type="radio"/>	2	SPDIF_OUT	20	30
<input type="radio"/>	3	VCC5V		

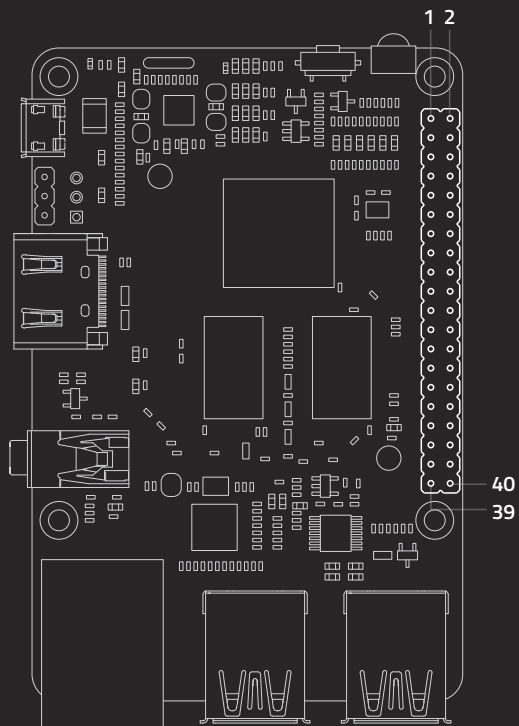



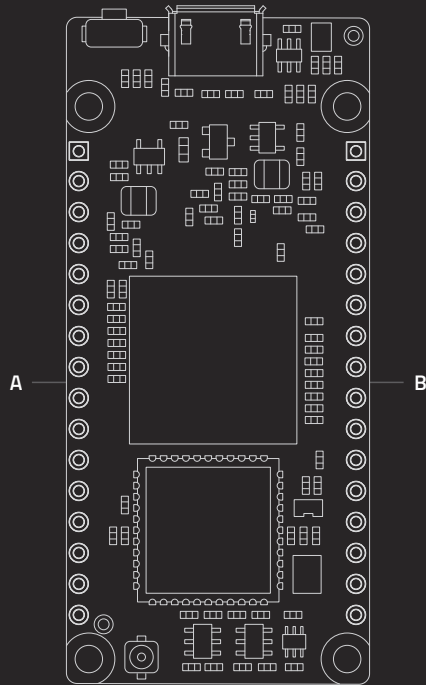

ALT	ALT	MAIN	#	A
IN/OUT		5V	1	□
IN/OUT		5V	2	○
OUT		3V3	3	○
GND		GND	4	○
PL11		IRRX	5	○
PG11		PG11	6	○
D-	USB3	DM3	7	○
D+	USB3	DP3	8	○
D-	USB2	DM2	9	○
D+	USB2	DP2	10	○
RXN	EPHY	RD-	11	○
RXP	EPHY	RD+	12	○
TXN	EPHY	TD-	13	○
TXP	EPHY	TD+	14	○
LED-LINK	EPHY	LNK	15	○
LED-SPD	EPHY	SPD	16	○

#	MAIN	ALT	ALT	ALT
1	RXD	DEBUG	RX	PA5
2	TXD	UART0	TX	PA4
3	GND			GND
4	SCL	I2C0	SCL	PA11
5	SDA	I2C0	SDA	PA12
6	CS	SPI1	CS	PA13
7	CLK	SPI1	CLK	PA14
8	MISO	SPI1	MISO	PA16
9	MOSI	SPI1	MOSI	PA15
10	RX1	UART1	RX	PG7
11	TX1	UART1	TX	PG6
12	CVBS	CVBS		CVBS
13	LL	LINEOUT		L
14	LR	LINEOUT		R
15	MP	MIC		P
16	MN	MIC		N

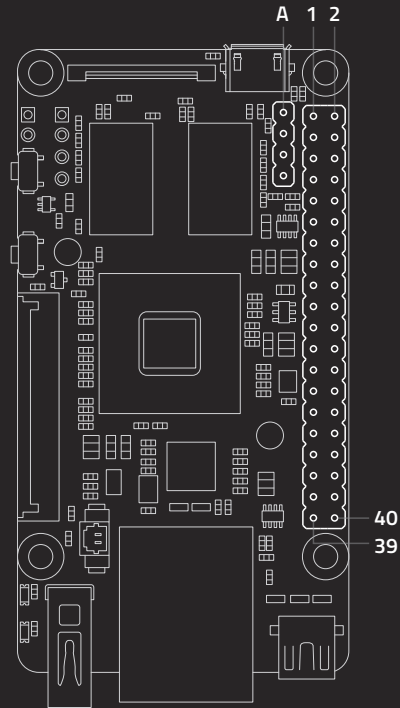



NAME	#			#	NAME
SYS_3.3V	1	<input type="checkbox"/>	<input type="radio"/>	2	VDD_5V
I2CO_SDA	3	<input type="radio"/>	<input type="radio"/>	4	VDD_5V
I2CO_SCL	5	<input type="radio"/>	<input type="radio"/>	6	DGND
GPIOB8/PPM	7	<input type="radio"/>	<input type="radio"/>	8	UART3_TXD/GPIOD21
DGND	9	<input type="radio"/>	<input type="radio"/>	10	UART3_RXD/GPIOD17
UART4_TX/GPIOB29	11	<input type="radio"/>	<input type="radio"/>	12	GPIOD1/PWM0
GPIOB30	13	<input type="radio"/>	<input type="radio"/>	14	DGND
GPIOB31	15	<input type="radio"/>	<input type="radio"/>	16	GPIOC14/PWM2
SYS_3.3V	17	<input type="radio"/>	<input type="radio"/>	18	GPIOB27
SPIO_MOSI/GPIOC31	19	<input type="radio"/>	<input type="radio"/>	20	DGND
SPIO_MISO/GPIOD0	21	<input type="radio"/>	<input type="radio"/>	22	UART4_RX/GPIOB28
SPIO_CLK/GPIOC29	23	<input type="radio"/>	<input type="radio"/>	24	SPIO_CS/GPIOC30
DGND	25	<input type="radio"/>	<input type="radio"/>	26	GPIOB26
I2C1_SDA	27	<input type="radio"/>	<input type="radio"/>	28	I2C1_SCL
GPIOC8	29	<input type="radio"/>	<input type="radio"/>	30	DGND
GPIOC7	31	<input type="radio"/>	<input type="radio"/>	32	GPIOC28
GPIOC13/PWM1	33	<input type="radio"/>	<input type="radio"/>	34	DGND
SPI2_MISO/GPIOC11	35	<input type="radio"/>	<input type="radio"/>	36	SPI2_CS/GPIOC10
ALIVEGPIO3	37	<input type="radio"/>	<input type="radio"/>	38	SPI2_MOSI/GPIOC12
DGND	39	<input type="radio"/>	<input type="radio"/>	40	SPI2_CLK/GPIOC9

A	#	NAME
<input type="checkbox"/>	1	DGND
<input type="radio"/>	2	VDD_5V
<input type="radio"/>	3	UART_TXD0
<input type="radio"/>	4	UART_RXD0

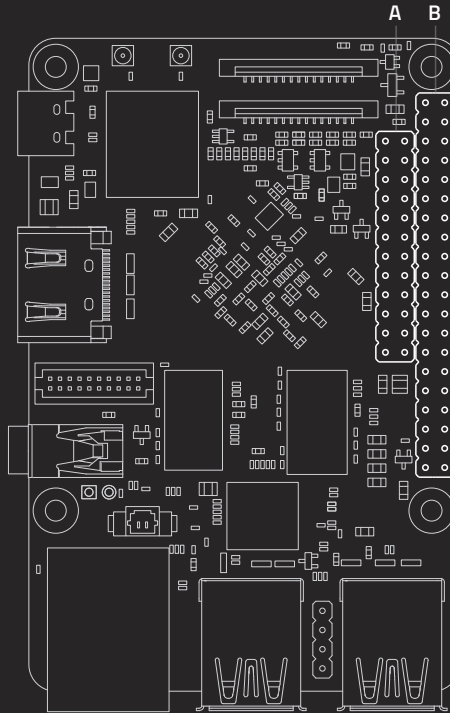



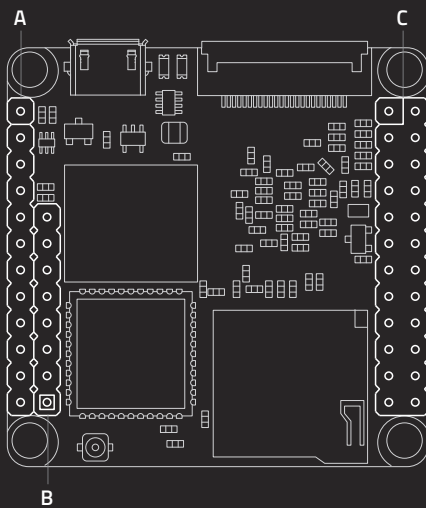

NAME			#
5V (OUT)			1
D+		USB2	2
D-		USB2	3
D+		USB3	4
D-		USB3	5
PL11	RX	IR	6
PA17	OUT	SPDIF	7
LRCK		1250	8
BCK		1250	9
DOUT		1250	10
DIN		1250	11
GND			12

A	B
<input type="checkbox"/>	<input type="checkbox"/>
<input type="radio"/>	<input type="radio"/>
<input type="radio"/>	<input type="radio"/>
<input type="radio"/>	<input type="radio"/>
<input type="radio"/>	<input type="radio"/>
<input type="radio"/>	<input type="radio"/>
<input type="radio"/>	<input type="radio"/>
<input type="radio"/>	<input type="radio"/>
<input type="radio"/>	<input type="radio"/>
<input type="radio"/>	<input type="radio"/>
<input type="radio"/>	<input type="radio"/>

#	NAME	
1	GND	
2	5V (OUT)	
3	UART0	TX
4	UART0	RX
5	LINEOUT	LL
6	LINEOUT	LR
7	LINEIN	MN
8	LINEIN	MP

NAME			#
3.3V (OUT)			1
SDA		I2C0	3
SCL		I2C0	5
PG11			7
GND			9
PA0	TX	UART2	11
PA2	RTS	UART2	13
PA3	CTS	UART2	15
3.3V (OUT)			17
PC0	MOSI	SPIO	19
PC1	MISO	SPIO	21
PC2	CLK	SPIO	23

C
<input type="checkbox"/> <input type="radio"/>
<input type="radio"/> <input type="radio"/>
<input type="radio"/> <input type="radio"/>
<input type="radio"/> <input type="radio"/>
<input type="radio"/> <input type="radio"/>
<input type="radio"/> <input type="radio"/>
<input type="radio"/> <input type="radio"/>
<input type="radio"/> <input type="radio"/>
<input type="radio"/> <input type="radio"/>
<input type="radio"/> <input type="radio"/>
<input type="radio"/> <input type="radio"/>

#	NAME		
2	5V (IN/OUT)		
4	5V (IN/OUT)		
6	GND		
8	UART1	TX	PG6
10	UART1	RX	PG7
12	PA6		
14	GND		
16	UART1	RTS	PG8
18	UART1	CTS	PG9
20	GND		
22	UART2	RX	PA1
24	SPIO	CS	PC3

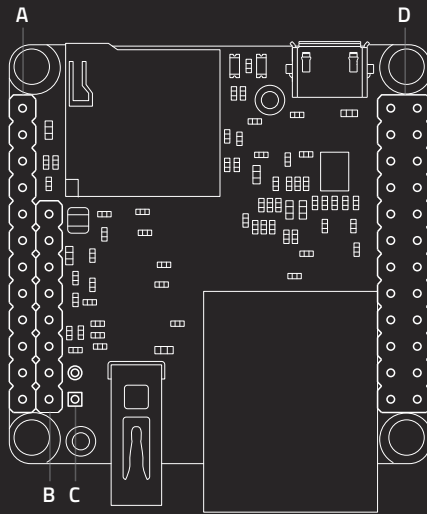

NAME			#
5V (OUT)			1
D+		USB1	2
D-		USB1	3
D+		USB2	4
D-		USB2	5
PL11	RX	IR	6
PA17	OUT	SPDIF	7
LRCK		1250	8
BCK		1250	9
DOUT		1250	10
DIN		1250	11
GND			12

A	B
<input type="checkbox"/>	<input type="checkbox"/>
<input type="radio"/>	<input type="radio"/>
<input type="radio"/>	<input type="radio"/>
<input type="radio"/>	<input type="radio"/>
<input type="radio"/>	<input type="radio"/>
<input type="radio"/>	<input type="radio"/>
<input type="radio"/>	<input type="radio"/>
<input type="radio"/>	<input type="radio"/>
<input type="radio"/>	<input type="radio"/>
<input type="radio"/>	<input type="radio"/>
<input type="radio"/>	<input type="radio"/>
<input type="radio"/>	<input type="radio"/>
<input type="radio"/>	<input type="radio"/>
<input type="radio"/>	<input type="radio"/>

#	NAME	
1	GND	
2	5V (OUT)	
3	UART0	TX
4	UART0	RX
5	LINEOUT	LL
6	LINEOUT	LR
7	LINEIN	MN
8	LINEIN	MP

C
<input type="checkbox"/>
<input type="radio"/>
<input type="radio"/>

#	NAME
1	GND
2	CVBS

NAME			#
3.3V (OUT)			1
SDA		I2C0	3
SCL		I2C0	5
PG11			7
GND			9
PA0	TX	UART2	11
PA2	RTS	UART2	13
PA3	CTS	UART2	15
3.3V (OUT)			17
PC0	MOSI	SPIO	19
PC1	MISO	SPIO	21
PC2	CLK	SPIO	23

D	
<input type="checkbox"/>	<input type="radio"/>
<input type="radio"/>	<input type="radio"/>
<input type="radio"/>	<input type="radio"/>
<input type="radio"/>	<input type="radio"/>
<input type="radio"/>	<input type="radio"/>
<input type="radio"/>	<input type="radio"/>
<input type="radio"/>	<input type="radio"/>
<input type="radio"/>	<input type="radio"/>
<input type="radio"/>	<input type="radio"/>
<input type="radio"/>	<input type="radio"/>
<input type="radio"/>	<input type="radio"/>
<input type="radio"/>	<input type="radio"/>
<input type="radio"/>	<input type="radio"/>
<input type="radio"/>	<input type="radio"/>

#	NAME		
2	5V (IN/OUT)		
4	5V (IN/OUT)		
6	GND		
8	UART1	TX	PG6
10	UART1	RX	PG7
12	PA6		
14	GND		
16	UART1	RTS	PG8
18	UART1	CTS	PG9
20	GND		
22	UART2	RX	PA1
24	SPIO	CS	PC3

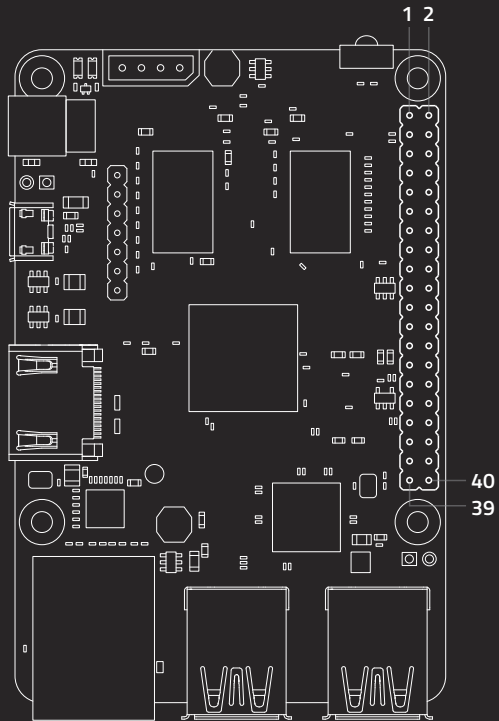



GPIO #	MAIN FUNCTIONS	#			#	MAIN FUNCTIONS	GPIO #
	3.3V POWER	1	<input type="checkbox"/>	<input type="radio"/>	2	5.0V POWER	
493	I2C_EE_M2_SDA/GPIOX_17	3	<input type="radio"/>	<input type="radio"/>	4	5.0V POWER	
494	I2C_EE_M2_SCL/GPIOX_18	5	<input type="radio"/>	<input type="radio"/>	6	GROUND	
481	PWM_C/GPIOX_5	7	<input type="radio"/>	<input type="radio"/>	8	GPXIO_12/UART_EE_A_TX	488
	GROUND	9	<input type="radio"/>	<input type="radio"/>	10	GPIOX_13/UART_EE_A_RX	489
479	PWM_D/GPIOX_3	11	<input type="radio"/>	<input type="radio"/>	12	GPXIO_16/PWM_E	492
480	GPIOX_4	13	<input type="radio"/>	<input type="radio"/>	14	GROUND	
483	GPIOX_7/PWM_F	15	<input type="radio"/>	<input type="radio"/>	16	GPIOX_0	476
	3.3V POWER	17	<input type="radio"/>	<input type="radio"/>	18	GPIOX_1	477
484	SPI_A_MOSI/GPIOX_8	19	<input type="radio"/>	<input type="radio"/>	20	GROUND	
485	SPI_A_MISO/GPIOX_9	21	<input type="radio"/>	<input type="radio"/>	22	GPIOX_2	478
487	SPI_A_SCLK/GPIOX_11	23	<input type="radio"/>	<input type="radio"/>	24	GPIOX_10/SPI_A_SS0	486
	GROUND	25	<input type="radio"/>	<input type="radio"/>	26	GPIOH_6	433
474	I2C_EE_M3_SDA/GPIOA_14	27	<input type="radio"/>	<input type="radio"/>	28	GPIOA_15/I2C_EE_M3_SCL	475
490	UART_EE_A_CTS/GPIOX_14	29	<input type="radio"/>	<input type="radio"/>	30	GROUND	
491	UART_EE_A_RTS/GPIOX_15	31	<input type="radio"/>	<input type="radio"/>	32	GPIOH_7	434
482	PWM_A/GPIOX_6	33	<input type="radio"/>	<input type="radio"/>	34	GROUND	
492	PWM_B/GPIOX_19	35	<input type="radio"/>	<input type="radio"/>	36	GPIOH_5/PWM_F	432
	ADC.AIN2	37	<input type="radio"/>	<input type="radio"/>	38	VDDIO_A01V8	
	GROUND	39	<input type="radio"/>	<input type="radio"/>	40	ADC.AIN0	

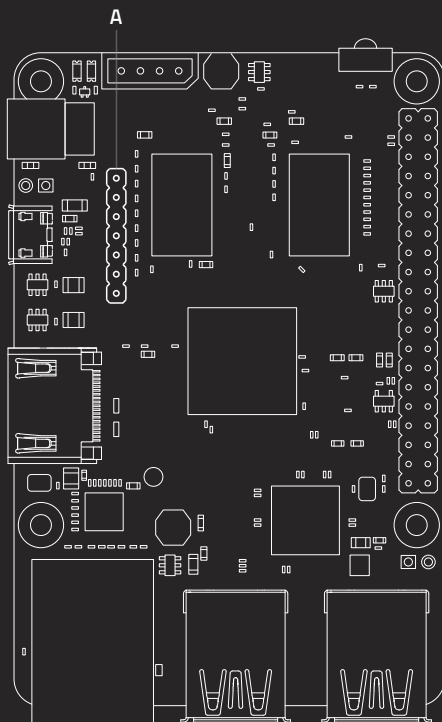

A	#	NAME	ALT	GPIO #
<input type="checkbox"/>	1	GND		
<input type="radio"/>	2	GPIOA0.10	SPDIF OUTPUT	506
<input type="radio"/>	3	5.0V		
<input type="radio"/>	4	GPIOA0.9	I2S MCLK	505
<input type="radio"/>	5	GPIOA0.7	I2S LRCLK	503
<input type="radio"/>	6	GPIOA0.8	I2S SCLK	504
<input type="radio"/>	7	GPIOA0.4	I2S DATA OUTPUT	500

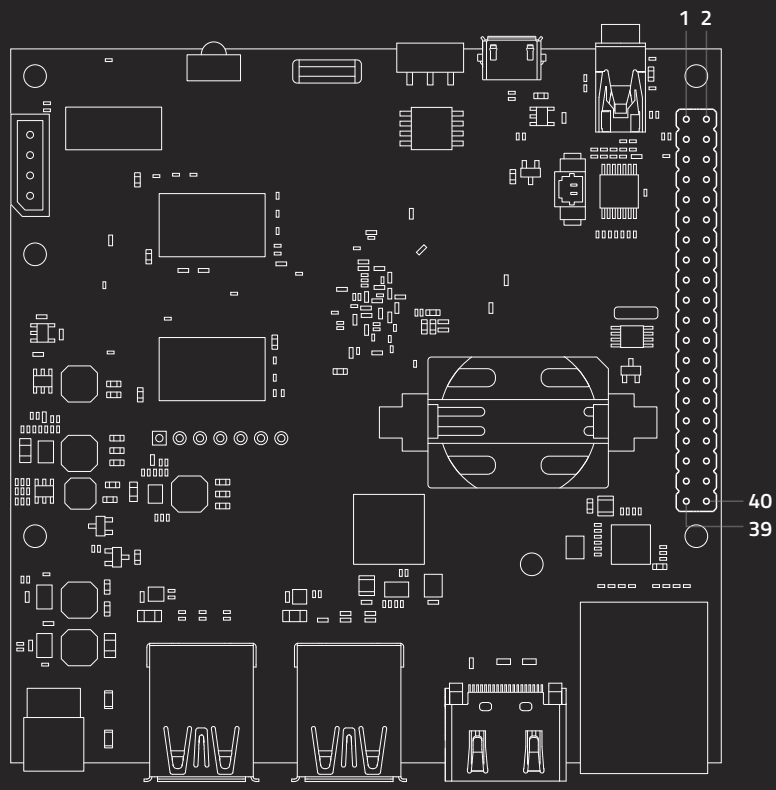

GPIO #	MAIN FUNCTIONS	#			#	MAIN FUNCTIONS	GPIO #
	3.3V POWER	1	<input type="checkbox"/>	<input type="radio"/>	2	5.0V POWER	
493	I2C_EE_M2_SDA/GPIOX_17	3	<input type="radio"/>	<input type="radio"/>	4	5.0V POWER	
494	I2C_EE_M2_SCL/GPIOX_18	5	<input type="radio"/>	<input type="radio"/>	6	GROUND	
473	SPDIF_OUT_GPIOA_13	7	<input type="radio"/>	<input type="radio"/>	8	GPXIO_12/UART_EE_A_TX	488
	GROUND	9	<input type="radio"/>	<input type="radio"/>	10	GPIOX_13/UART_EE_A_RX	489
479	PWM_D/GPIOX_3	11	<input type="radio"/>	<input type="radio"/>	12	GPXIO_16/PWM_E	492
480	GPIOX_4	13	<input type="radio"/>	<input type="radio"/>	14	GROUND	
483	PWM_B/PWM_F/GPIOX_7	15	<input type="radio"/>	<input type="radio"/>	16	GPIOX_0	476
	3.3V POWER	17	<input type="radio"/>	<input type="radio"/>	18	GPIOX_1	477
484	SPI_A_MOSI/GPIOX_8	19	<input type="radio"/>	<input type="radio"/>	20	GROUND	
485	SPI_A_MISO/GPIOX_9	21	<input type="radio"/>	<input type="radio"/>	22	GPIOX_2	478
487	SPI_A_SCLK/GPIOX_11	23	<input type="radio"/>	<input type="radio"/>	24	GPIOX_10/SPI_A_SS0	486
	GROUND	25	<input type="radio"/>	<input type="radio"/>	26	GPIOA_4	464
474	I2C_EE_M3_SDA/GPIOA_14	27	<input type="radio"/>	<input type="radio"/>	28	GPIOA_15/I2C_EE_M3_SCL	475
490	UART_EE_A_CTS/GPIOX_14	29	<input type="radio"/>	<input type="radio"/>	30	GROUND	
491	UART_EE_A_RTS/GPIOX_15	31	<input type="radio"/>	<input type="radio"/>	32	GPIOH_12	472
481	PWM_C/GPIOX_5	33	<input type="radio"/>	<input type="radio"/>	34	GROUND	
482	PWM_D/GPIOX_6	35	<input type="radio"/>	<input type="radio"/>	36	PWM_B/GPIOX_19	495
	ADC.AIN3	37	<input type="radio"/>	<input type="radio"/>	38	VDDIO_A01V8	
	GROUND	39	<input type="radio"/>	<input type="radio"/>	40	ADC.AIN2	





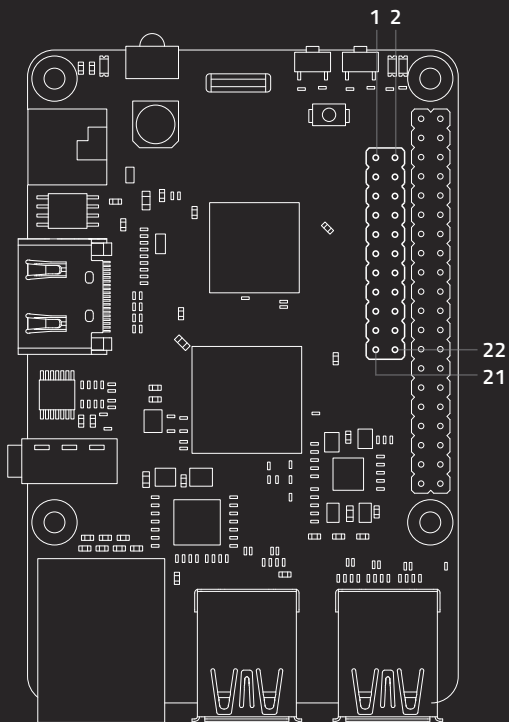



GPIO #	MAIN FUNCTIONS	#
	3.3V	1
81	GPIO2_C1 (I2S1_LRCKTX)	3
87	GPIO2_C7 (I2S1_SDO)	5
	GROUND	7
80	GPIO2_C0 (I2S1_LRCKRX)	9
85	GPIO2_C5 (I2S1_SDIO2)	11
27	GPIO0_D3 (SPDIF_TX_M0)	13
	GROUND	15
	ETHERNET RD+	17
	ETHERNET TX+	19
89	GPIO2_D1 (ETHERNET SPEED)	21

<input type="checkbox"/>	<input type="radio"/>
<input type="radio"/>	<input type="radio"/>
<input type="radio"/>	<input type="radio"/>
<input type="radio"/>	<input type="radio"/>
<input type="radio"/>	<input type="radio"/>
<input type="radio"/>	<input type="radio"/>
<input type="radio"/>	<input type="radio"/>
<input type="radio"/>	<input type="radio"/>
<input type="radio"/>	<input type="radio"/>
<input type="radio"/>	<input type="radio"/>

#	MAIN FUNCTIONS	GPIO #
2	5V	
4	GPIO2_C2 (I2S1_SCLK)	82
6	GPIO2_C3 (I2S1_SDI)	83
8	GROUND	
10	GPIO2_B7 (I2S1_MCLK)	79
12	GPIO2_C4 (I2S1_SDIO1)	84
14	GPIO2_C6 (I2S1_SDIO3)	86
16	GROUND	
18	ETHERNET RD-	
20	ETHERNET TX-	
22	GPIO2_D0 (ETHERNET LINK)	88

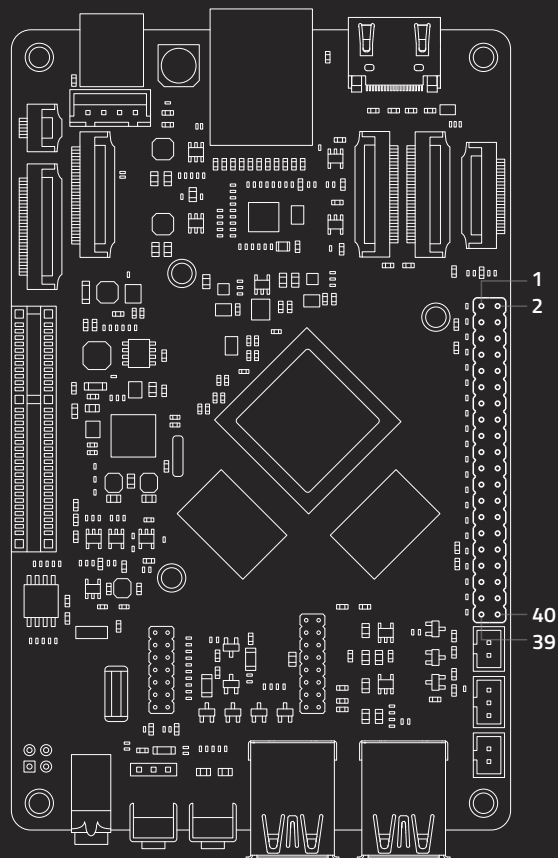

MAIN FUNCTIONS	#			#	MAIN FUNCTIONS
3.3V	1	<input type="checkbox"/>	<input type="radio"/>	2	5V
GPIO1_C4 (I2C8_SDA)	3	<input type="radio"/>	<input type="radio"/>	4	5V
GPIO1_C5 (I2C8_SCL)	5	<input type="radio"/>	<input type="radio"/>	6	GROUND
GPIO4_D0 (CPU_GPCLK)	7	<input type="radio"/>	<input type="radio"/>	8	GPIO4_C4 (UART2_TX)
GROUND	9	<input type="radio"/>	<input type="radio"/>	10	GPIO4_C3 (UART2_RX)
GPIO1_C6	11	<input type="radio"/>	<input type="radio"/>	12	GPIO3_D0 (I2S0_CLK)
GPIO1_C2	13	<input type="radio"/>	<input type="radio"/>	14	GROUND
GPIO1_A1	15	<input type="radio"/>	<input type="radio"/>	16	GPIO1_A4
3.3V	17	<input type="radio"/>	<input type="radio"/>	18	GPIO4_C5 [SPDIF]
[UART4_TX] GPIO1_B0 (SPI1_TXD)	19	<input type="radio"/>	<input type="radio"/>	20	GROUND
[UART4_RX] GPIO1_A7 (SPI1_RXD)	21	<input type="radio"/>	<input type="radio"/>	22	GPIO4_D1
GPIO1_B1 (SPI1_CLK)	23	<input type="radio"/>	<input type="radio"/>	24	GPIO1_B2 (SPI1_CSNO)
GROUND	25	<input type="radio"/>	<input type="radio"/>	26	GPIO1_B5
GPIO1_B3 (I2C4_SDA)	27	<input type="radio"/>	<input type="radio"/>	28	GPIO1_B4 (I2C4_SCL)
GPIO4_D3	29	<input type="radio"/>	<input type="radio"/>	30	GROUND
GPIO4_D4	31	<input type="radio"/>	<input type="radio"/>	32	GPIO3_D4 (I2S0_SDI1SDO3)
GPIO3_D5 (I2S0_SDI2SDO2)	33	<input type="radio"/>	<input type="radio"/>	34	GROUND
GPIO3_D2 (I2S0_LRCKTX)	35	<input type="radio"/>	<input type="radio"/>	36	GPIO3_D6 (I2S0_SDI3SDO1)
GPIO3_D1 (I2S0_LRCKRX)	37	<input type="radio"/>	<input type="radio"/>	38	GPIO3_D3 (I2S0_SDI0)
GROUND	39	<input type="radio"/>	<input type="radio"/>	40	GPIO3_D7 (I2S0_SD00)

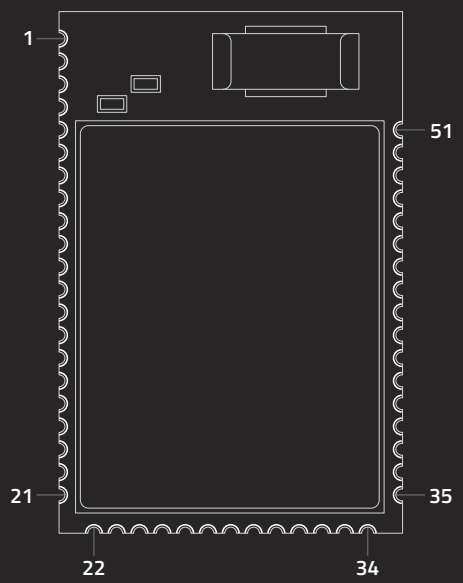

#	NAME	NOTES	#	NAME	NOTES
1	GND	COMMON GROUND	26	PIO_4	PROGRAMMABLE I/O
2	GND	COMMON GROUND	27	GND	COMMON GROUND
3	GND	COMMON GROUND	28	VREGEN	SEE NOTE*
4	GND	COMMON GROUND	29	CHG_EXT	BATTERY CHARGER CTRL
5	PIO_6	PROGRAMMABLE I/O	30	VCHG	BATTERY INPUT
6	PIO_7	PROGRAMMABLE I/O	31	VBAT_SENSE	BATTERY SENSE
7	CAP_SENSE_1	TOUCH SENSE INPUT (ANALOG)	32	VBAT	BATTERY (+)
8	CAP_SENSE_4	TOUCH SENSE INPUT (ANALOG)	33	VDD_PADS	POSITIVE SUPPLY INPUT (3.3V - 4.7V)**
9	CAP_SENSE_3	TOUCH SENSE INPUT (ANALOG)	34	3V3_USB	POSITIVE SUPPLY INPUT (3.3V - 4.7V)**
10	CAP_SENSE_2	TOUCH SENSE INPUT (ANALOG)	35	USB_N	USB DATA (-)
11	GND	COMMON GROUND	36	USB_P	USB DATA (+)
12	AIO_1	ANALOG PROGRAMMABLE I/O	37	LED_0	LED DRIVER (OPEN DRAIN OUTPUT)
13	SPKR_LN	SPEAKER OUTPUT (-) LEFT	38	LED_1	LED DRIVER (OPEN DRAIN OUTPUT)
14	SPKR_LP	SPEAKER OUTPUT (+) LEFT	39	LED_2	LED DRIVER (OPEN DRAIN OUTPUT)
15	SPKR_RN	SPEAKER OUTPUT (-) RIGHT	40	UART_CTS	UART CLEAR TO SEND
16	SPKR_RP	SPEAKER OUTPUT (+) RIGHT	41	UART_TX	UART TX DATA
17	MIC_BIAS_A	MIC BIAS	42	UART_RX	UART RX DATA
18	MIC_RN	MIC INPUT (-) RIGHT (ANALOG)	43	UART_RTS	UART REQUEST TO SEND
19	MIC_RP	MIC INPUT (+) RIGHT (ANALOG)	44	RST#	RESET INPUT
20	MIC_LN	MIC INPUT (-) LEFT (ANALOG)	45	SPI_PCM#	SELECT PCM/SPI
21	MIC_LP	MIC INPUT (+) LEFT (ANALOG)	46	PCM_SYNC	SYNCHRONOUS DATA SYNC
22	GND	COMMON GROUND	47	PCM_CLK	SYNCHRONOUS DATA CLOCK
23	PIO_0	PROGRAMMABLE I/O	48	PCM_OUT	SYNCHRONOUS DATA OUTPUT (CMOS)
24	PIO_1	PROGRAMMABLE I/O	49	PCM_IN	SYNCHRONOUS DATA INPUT (CMOS)
25	PIO_5	PROGRAMMABLE I/O	50	PIO_2	PROGRAMMABLE I/O
			51	PIO_3	PROGRAMMABLE I/O

\*Take High to Enable Switch-Mode Regulator \*\*Typical Current 15mA (Music Streaming), Typical Current Idle < 1mA (Connectable)

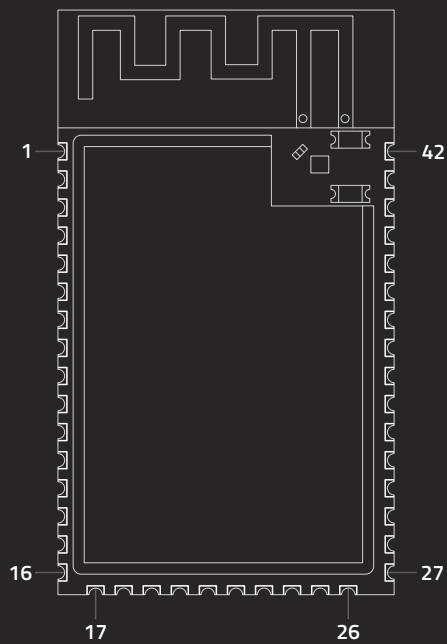

#	NAME	NOTES	#	NAME	NOTES
1	GND	GROUND	22	IO19	RTC19, IO19, U1RTS, ADC2_CH8, CLK_OUT2, USB_D-
2	3V3	POWER SUPPLY (OPERATING VOLTAGE 3.0 ~ 3.6 V)	23	IO20	RTC20, IO20, U1CTS, ADC2_CH9, CLK_OUT1, USB_D+
3	IO0	RTC0, IO0	24	IO21	RTC21, IO21
4	IO1	RTC1, IO1, TOUCH1, ADC1_CH0	25	IO26	SPICS1, IO26*
5	IO2	RTC2, IO2, TOUCH2, ADC1_CH1	26	GND	GROUND
6	IO3	RTC3, IO3, TOUCH3, ADC1_CH2	27	IO33	SPIIO4, IO33, FSPIHD
7	IO4	RTC4, IO4, TOUCH4, ADC1_CH3	28	IO34	SPIIO5, IO34, FSPIC50
8	IO5	RTC5, IO5, TOUCH5, ADC1_CH4	29	IO35	SPIIO6, IO35, FSPID
9	IO6	RTC6, IO6, TOUCH6, ADC1_CH5	30	IO36	SPIIO7, IO36, FSPICLK
10	IO7	RTC7, IO7, TOUCH7, ADC1_CH6	31	IO37	SPIDQS, IO37, FSPIQ
11	IO8	RTC8, IO8, TOUCH8, ADC1_CH7	32	IO38	IO38, FSPIWP
12	IO9	RTC9, IO9, TOUCH9, ADC1_CH8, FSPIHD	33	IO39	MTCK, IO39, CLK_OUT3
13	IO10	RTC10, IO10, TOUCH10, ADC1_CH9, FSPIC50, FSPIIO4	34	IO40	MTDO, IO40, CLK_OUT2
14	IO11	RTC11, IO11, TOUCH11, ADC2_CH0, FSPID, FSPIIO5	35	IO41	MTDI, IO41, CLK_OUT1
15	IO12	RTC12, IO12, TOUCH12, ADC2_CH1, FSPICLK, FSPIIO6	36	IO42	MTMS, IO42
16	IO13	RTC13, IO13, TOUCH13, ADC2_CH2, FSPIQ, FSPIIO7	37	TXD0	U0TXD, IO43, CLK_OUT1
17	IO14	RTC14, IO14, TOUCH14, ADC2_CH3, FSPIWP, FSPIDQS	38	RXD0	U0RXD, IO44, CLK_OUT2
18	IO15	RTC15, IO15, U0RTS, ADC2_CH4, XTAL_32K_P	39	IO45	IO45
19	IO16	RTC16, IO16, U0CTS, ADC2_CH5, XTAL_32K_N	40	IO46	IO46
20	IO17	RTC17, IO17, U1TXD, ADC2_CH6, DAC_1	41	EN	SEE NOTE**
21	IO18	RTC18, IO18, U1RXD, ADC2_CH7, DAC_2, CLK_OUT3	42	GND	GROUND

\*By default, IO26 is connected to the CS pin of the PSRAM and cannot be used for other functions

\*\*High: on, enables the chip. Low: off, the chip powers off. Note: Do not leave the EN pin floating.

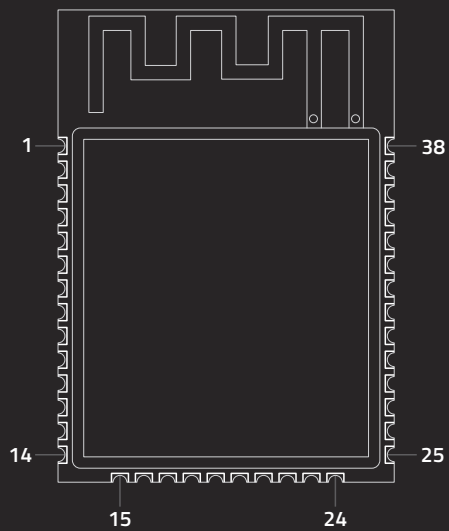



#	NAME	NOTES	#	NAME	NOTES
1	GND	GROUND	20	SCK/CLK*	IO6, SD_CLK, SPICLK, HS1_CLK, U1CTS
2	3V3	POWER (OPERATING VOLTAGE 3.0 ~ 3.6 V)	21	SDO/SD0*	IO7, SD_DATA0, SPIQ, HS1_DATA0, U2RTS
3	EN	MODULE-ENABLE SIGNAL. ACTIVE HIGH	22	SDI/SD1*	IO8, SD_DATA1, SPID, HS1_DATA1, U2CTS
4	SENSOR_VP	IO36, ADC1_CH0, RTC0	23	IO15	IO15, ADC2_CH3, TOUCH3, MTDO, HSPIC50, RTC13, HS2_CMD, SD_CMD, EMAC_RXD3
5	SENSOR_VN	IO39, ADC1_CH3, RTC3			
6	IO34	IO34, ADC1_CH6, RTC4	24	IO2	IO2, ADC2_CH2, TOUCH2, RTC12, HSPiWP, HS2_DATA0, SD_DATA0
7	IO35	IO35, ADC1_CH7, RTC5	25	IO0	IO0, ADC2_CH1, TOUCH1, RTC11, CLK_OUT1, EMAC_TX_CLK
8	IO32	IO32, XTAL_32K_P, ADC1_CH4, TOUCH9, RTC9			
9	IO33	IO33, XTAL_32K_N, ADC1_CH5, TOUCH8, RTC8	26	IO4	IO4, ADC2_CH0, TOUCH0, RTC10, HSPiHD, HS2_DATA1, SD_DATA1, EMAC_TX_ER
10	IO25	IO25, DAC_1, ADC2_CH8, RTC6, EMAC_RXD0	27	IO16	IO16, HS1_DATA4, U2RXD, EMAC_CLK_OUT
11	IO26	IO26, DAC_2, ADC2_CH9, RTC7, EMAC_RXD1	28	IO17	IO17, HS1_DATA5, U2TXD, EMAC_CLK_OUT_180
12	IO27	IO27, ADC2_CH7, TOUCH7, RTC17, EMAC_RX_DV	29	IO5	IO5, VSPIC50, HS1_DATA6, EMAC_RX_CLK
13	IO14	IO14, ADC2_CH6, TOUCH6, RTC16, MTMS, HSPICLK, HS2_CLK, SD_CLK, EMAC_TXD2	30	IO18	IO18, VSPICLK, HS1_DATA7
			31	IO19	IO19, VSPIQ, U0CTS, EMAC_TXD0
14	IO12	IO12, ADC2_CH5, TOUCH5, RTC15, MTDI, HSPIQ, HS2_DATA2, SD_DATA2, EMAC_TXD3	32	NC	-
15	GND	GROUND	33	IO21	IO21, VSPiHD, EMAC_TX_EN
			34	RXD0	IO3, U0RXD, CLK_OUT2
16	IO13	IO13, ADC2_CH4, TOUCH4, RTC14, MTCK, HSPID, HS2_DATA3, SD_DATA3, EMAC_RX_ER	35	TXD0	IO1, U0TXD, CLK_OUT3, EMAC_RXD2
17	SHD/SD2*	IO9, SD_DATA2, SPiHD, HS1_DATA2, U1RXD	36	IO22	IO22, VSPiWP, U0RTS, EMAC_TXD1
18	SWP/SD3*	IO10, SD_DATA3, SPiWP, HS1_DATA3, U1TXD	37	IO23	IO23, VSPID, HS1_STROBE
19	SCS/CMD*	IO11, SD_CMD, SPIC50, HS1_CMD, U1RTS	38	GND	GROUND

\* Pins SCK/CLK, SDO/SD0, SDI/SD1, SHD/SD2, SWP/SD3 and SCS/CMD, namely, GPIO6 to GPIO11 are connected to the integrated SPI flash integrated on the module and are not recommended for other uses.

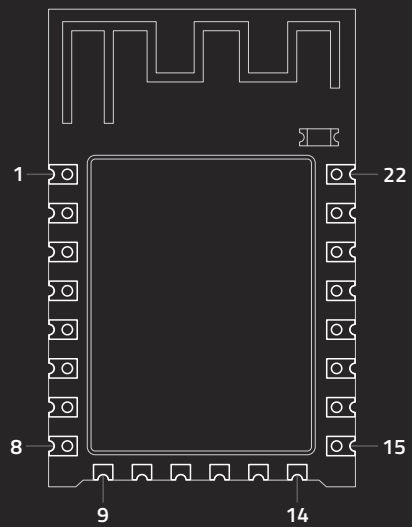

#	NAME	NOTES
1	RST	EXTERNAL RESET SIGNAL (LOW VOLTAGE LEVEL: ACTIVE)
2	ADC	ANALOG-TO-DIGITAL CONVERTER
3	EN	CHIP ENABLE. HIGH: ON, CHIP WORKS PROPERLY; LOW: OFF, SMALL CURRENT
4	IO16	GPIO16; DEEP-SLEEP WAKEUP
5	IO14	GPIO14; HSPI_CLK
6	IO12	GPIO12; HSPI_MISO
7	IO13	GPIO13; HSPI_MOSI; UART0_CTS
8	VCC	POWER SUPPLY 3.0 ~3.6V
9	CS0	GPIO11; CONNECT TO SD_CMD (SERIES R: 200Ω); SPI_CS0
10	MISO	GPIO7; CONNECT TO SD_D0 (SERIES R: 200Ω); SPI_MSIO
11	IO9	GPIO9; CONNECT TO SD_D2 (SERIES R: 200Ω); SPIHD; HSPiHD
12	IO10	GPIO10; CONNECT TO SD_D3 (SERIES R: 200Ω); SPIWP; HSPiWP
13	MOSI	GPIO8; CONNECT TO SD_D1 (SERIES R: 200Ω); SPI_MOSI
14	SCLK	GPIO6; CONNECT TO SD_CLK (SERIES R: 200Ω); SPI_CLK
15	GND	GROUND
16	IO15	GPIO15; HSPI_CS; UART0_RTS
17	IO2	GPIO2; UART TX DURING FLASH PROGRAMMING
18	IO0	GPIO0; SPI_CS2
19	IO4	GPIO4
20	IO5	GPIO5
21	RXD0	GPIO3; UART RX DURING FLASH PROGRAMMING
22	TXD0	GPIO1; UART TX DURING FLASH PROGRAMMING; SPI_CS1

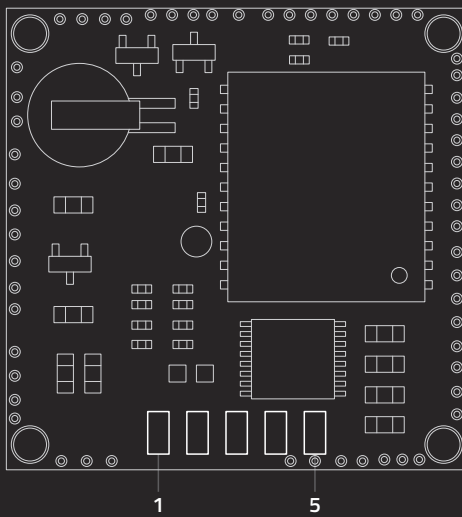

#	NAME	NOTES
1	VCC	POWER INPUT (4V ~ 6V)
2	RX	DATA INPUT (RS232 LEVEL)
3	TX	DATA OUTPUT (RS232 LEVEL)
4	GND	GROUND
5	GND	GROUND

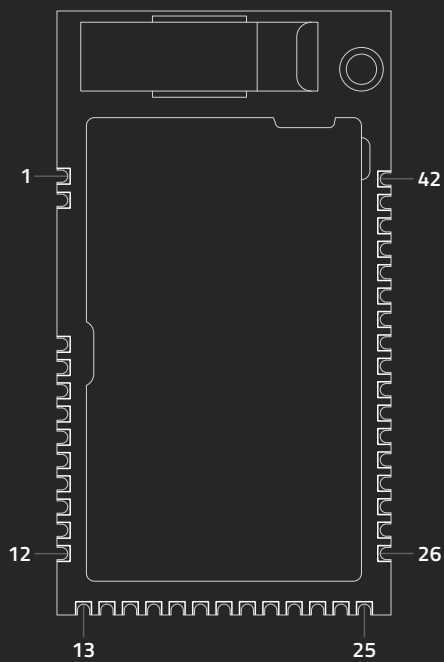

#	NAME	NOTES	#	NAME	NOTES	
1	GND	GROUND	22	P0.05	GENERAL-PURPOSE DIGITAL I/O; ADC INPUT 6	
2	GND	GROUND	23	P0.06	GENERAL-PURPOSE DIGITAL I/O; ADC INPUT 7	
3	AVDD	ANALOG POWER SUPPLY	24	P0.07	GENERAL-PURPOSE DIGITAL I/O	
4	P0.21	GENERAL-PURPOSE DIGITAL I/O	25	GND	GROUND	
5	P0.22		26	P0.08		
6	P0.23		27	P0.09		
7	P0.24		28	P0.10		
8	P0.25		29	P0.11		
9	XL2		CONNECTOR FOR 32.768KHZ CRYSTAL; ADC INPUT 0 GENERAL-PURPOSE DIGITAL I/O (P0.27)	30		P0.12
10	XL1	CONNECTOR FOR 32.768KHZ CRYSTAL; ADC INPUT 1 GENERAL-PURPOSE DIGITAL I/O (P0.27)	31	P0.13		
			32	P0.14		
11	P0.28	GENERAL-PURPOSE DIGITAL I/O	33	P0.15		
12	P0.29		34	P0.16		
13	GND	GROUND	35	SWDIO		SYSTEM RESET(ACTIVE LOW).ALSO HW DEBUG AND FLASH PROGRAMMING
14	VDD	POWER SUPPLY	36	SWCLK		HW DEBUG AND FLASH PROGRAMMING
15	DCC	DC/DC OUTPUT VOLTAGE TO EXTERNAL LC FILTER	37	P0.17		GENERAL-PURPOSE DIGITAL I/O
16	P0.30	GENERAL-PURPOSE DIGITAL I/O	38	P0.18		
17	P0.00	GENERAL-PURPOSE DIGITAL I/O; ADC REF VOLTAGE	39	P0.19		
18	P0.01	GENERAL-PURPOSE DIGITAL I/O; ADC INPUT 2	40	P0.20		
19	P0.02	GENERAL-PURPOSE DIGITAL I/O; ADC INPUT 3	41	DEC2	POWER SUPPLY DECOUPLING	
20	P0.03	GENERAL-PURPOSE DIGITAL I/O; ADC INPUT 4	42	GND	GROUND	
21	P0.04	GENERAL-PURPOSE DIGITAL I/O; ADC INPUT 5				

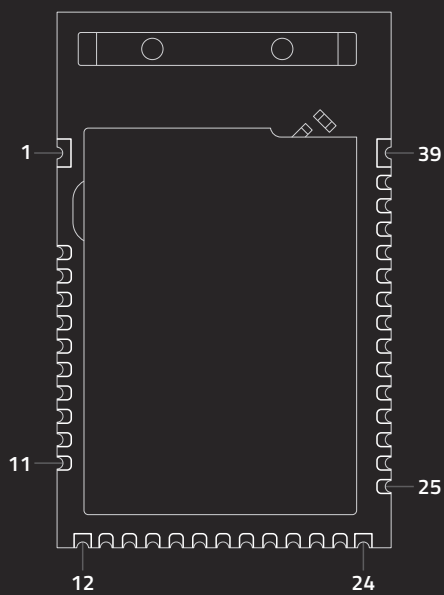



#	NAME	NOTES	#	NAME	NOTES
1	GND	GROUND	21	P0.08	GENERAL-PURPOSE DIGITAL I/O
2	P0.25	GENERAL-PURPOSE DIGITAL I/O	22	P0.09	GENERAL-PURPOSE DIGITAL I/O NFC ANTENNA CONNECTION
3	P0.26	GENERAL-PURPOSE DIGITAL I/O	23	P0.10	
4	P0.27	GENERAL-PURPOSE DIGITAL I/O	24	GND	GROUND
5	P0.28	GENERAL-PURPOSE DIGITAL I/O SAADC/COMP/LPCOMP INPUT	25	P0.11	GENERAL-PURPOSE DIGITAL I/O
6	P0.29		26	P0.12	
7	P0.30		27	P0.13	
8	P0.31		28	P0.14	GENERAL-PURPOSE DIGITAL I/O TRACE PORT OUTPUT
9	DEC4	1V3 REGULATOR SUPPLY DECOUPLING. INPUT FROM DC/DC CONVERTER. OUTPUT FROM 1V3 LDO	29	P0.15	
10	DCC	DC/DC CONVERTER OUTPUT PIN	30	P0.16	
11	VDD	POWER-SUPPLY PIN	31	P0.17	GENERAL-PURPOSE DIGITAL I/O
12	GND	GROUND	32	P0.18	GENERAL-PURPOSE DIGITAL I/O TRACE PORT OUTPUT
13	P0.00/XL1	GENERAL-PURPOSE DIGITAL I/O CONNECTION TO 32.768KHZ CRYSTAL (LFXO)	33	P0.19	GENERAL-PURPOSE DIGITAL I/O
14	P0.01/XL2		34	P0.20	GENERAL-PURPOSE DIGITAL I/O TRACE PORT CLOCK OUTPUT
15	P0.02	GENERAL-PURPOSE DIGITAL I/O SAADC/COMP/LPCOMP INPUT	35	P0.21/RST	GENERAL-PURPOSE DIGITAL I/O; RESET PIN
16	P0.03		36	SWDCLK	SERIAL WIRE DEBUG CLOCK INPUT
17	P0.04		37	SWDIO	SERIAL WIRE DEBUG I/O
18	P0.05		38	P0.22	GENERAL-PURPOSE DIGITAL I/O
19	P0.06	GENERAL-PURPOSE DIGITAL I/O	39	GND	GROUND
20	P0.07	GENERAL-PURPOSE DIGITAL I/O			

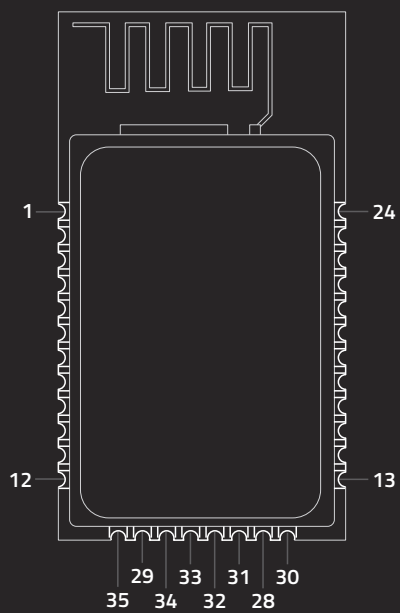

#	NAME	NOTES	#	NAME	NOTES
1	GND	GROUND	19	PIO2**	STATUS, HIGH WHEN CONNECTED, ELSE LOW
2	SPI MOSI*	PROGRAMMING ONLY	20	PIO3**	AUTO DISCOVERY = HIGH
3	PIO6**	SET BT MASTER (HIGH=AUTO-MASTER MODE)	21	PIO5**	STATUS, BASED ON STATE, LOW ON CONNECT
4	PIO7**	SET BAUD (HIGH = FORCE 9600, LOW = 115K)	22	PIO4**	SET FACTORY DEFAULTS
5	RESET	ACTIVE LOW RESET	23	SPI_CSB	PROGRAMMING ONLY
6	SPI_CLK	PROGRAMMING ONLY	24	SPI_MISO	PROGRAMMING ONLY
7	PCM_CLK	PCM INTERFACE	25	GND	GROUND FOR RN42-N
8	PCM_SYNC	PCM INTERFACE	26	RF PAD	RF PAD FOR RN42-N
9	PCM_IN	PCM INTERFACE	27	GND	GROUND FOR RN42-N
10	PCM_OUT	PCM INTERFACE	28	GND	GROUND
11	VDD	3.3V REGULATED POWER INPUT	29	GND	GROUND
12	GND	GND	30	AIO0	OPTIONAL ANALOG INPUT
13	UART_RX**	UART RECEIVE INPUT	31	PIO8**	STATUS (RF DATA RX/TX)
14	UART_TX**	UART TRANSMIT OUTPUT	32	PIO9**	IO
15	UART_RTS**	UART RTS, GOES HIGH TO DISABLE HOST TX	33	PIO10**	IO (REMOTE DTR SIGNAL)
16	UART_CTS**	UART CTS, IF SET HIGH, DISABLES TRANSMITTER	34	PIO11**	IO (REMOTE RTS SIGNAL)
17	USB_D+**	USB PORT	35	AIO1	OPTIONAL ANALOG INPUT
18	USB_D-**	USB PORT			

\*Pin Voltage: 3V \*\*Pin Voltage: 0V-3.3V

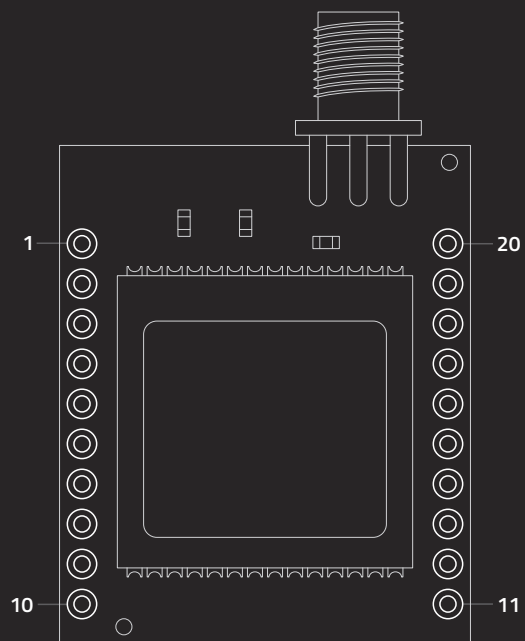

#	NAME	NOTES
1	LNA	LNA ENABLE. CAN BE USED WITH ACTIVE ANTENNAS ONLY. ACTIVE LOW LOGIC LEVEL SIGNAL TO CONTROL EXTERNAL LNA
2	VBAT	VOLTAGE SUPPLY FOR BACKUP BATTERY 2.7 - 3.3V
3	OPEN	ANTENNA OPEN. LOGIC LEVEL FROM EXTERNAL ANTENNA DETECTION CIRCUIT
4	SHORT	ANTENNA SHORT. LOGIC LEVEL FROM EXTERNAL ANTENNA DETECTION CIRCUIT
5	R1	RESERVED. DO NOT CONNECT
6	R2	RESERVED. DO NOT CONNECT
7	XRST	ACTIVE LOW LOGIC LEVEL RESET. DO NOT CONNECT IF NOT USED
8	VCC	MODULE POWER SUPPLY 2.7 - 3.3 VDC
9	GND	SIGNAL GROUND. CONNECT TO COMMON GROUND
10	XSTBY	SELECTS "RUN" OR "STANDBY" MODE. CONNECT TO VCC IF NOT USED (RUN ONLY)
11	R3	RESERVED. DO NOT CONNECT
12	R4	RESERVED. DO NOT CONNECT
13	PPS	PULSE PER SECOND. LOGIC LEVEL TIMING SIGNAL AT 1 HZ. DO NOT CONNECT IF NOT USED
14	RX-B	LOGIC LEVEL SECONDARY SERIAL PORT RECEIVE
15	RX-A	LOGIC LEVEL PRIMARY SERIAL PORT RECEIVE
16	R5	RESERVED. DO NOT CONNECT
17	TX-A	LOGIC LEVEL PRIMARY SERIAL PORT TRANSMIT
18	TX-B	LOGIC LEVEL SECONDARY SERIAL PORT TRANSMIT
19	R6	RESERVED. DO NOT CONNECT
20	R7	RESERVED. DO NOT CONNECT

CHIPS



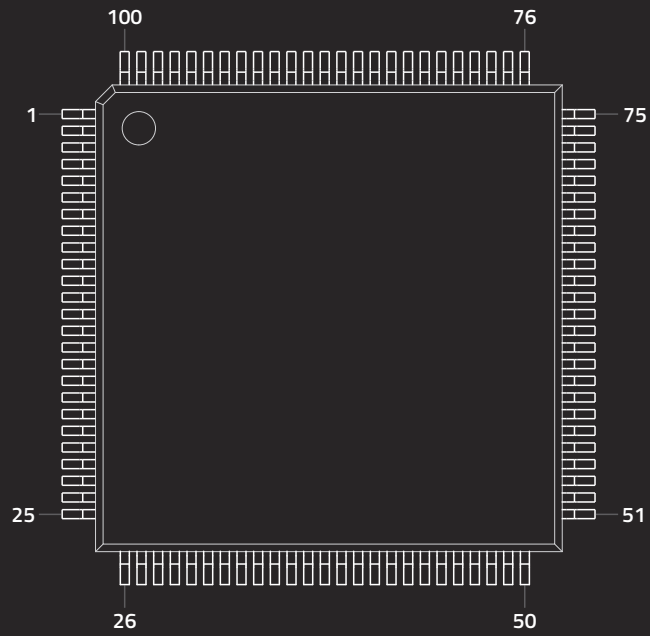



#	NAME	#	NAME	#	NAME	#	NAME
1	PG5 (OC0B)	26	PB7 (OC0A/OC1C/PCINT7)	51	PG0 (WR)	76	PA2 (AD2)
2	PE0 (RXD0/PCINT8)	27	PH7 (T4)	52	PG1 (RD)	77	PA1 (AD1)
3	PE1 (TXD0)	28	PG3 (TOSC2)	53	PC0 (A8)	78	PA0 (AD0)
4	PE2 (XCK0/AIN0)	29	PG4 (TOSC1)	54	PC1 (A9)	79	PJ7
5	PE3 (OC3A/AIN1)	30	RESET	55	PC2 (A10)	80	VCC (4.5V-5.5V)
6	PE4 (OC3B/INT4)	31	VCC (4.5V-5.5V)	56	PC3 (A11)	81	GND
7	PE5 (OC3C/INT5)	32	GND	57	PC4 (A12)	82	PK7 (ADC15/PCINT23)
8	PE6 (T3/INT6)	33	XTAL2	58	PC5 (A13)	83	PK6 (ADC14/PCINT22)
9	PE7 (CLK0/ICP3/INT7)	34	XTAL1	59	PC6 (A14)	84	PK5 (ADC13/PCINT21)
10	VCC (4.5V-5.5V)	35	PL0 (ICP4)	60	PC7 (A15)	85	PK4 (ADC12/PCINT20)
11	GND	36	PL1 (ICP5)	61	VCC (4.5V-5.5V)	86	PK3 (ADC11/PCINT19)
12	PH0 (RXD2)	37	PL2 (T5)	62	GND	87	PK2 (ADC10/PCINT18)
13	PH1 (TXD2)	38	PL3 (OC5A)	63	PJ0 (RXD3/PCINT9)	88	PK1 (ADC9/PCINT17)
14	PH2 (XCK2)	39	PL4 (OC5B)	64	PJ1 (TXD3/PCINT10)	89	PK0 (ADC8/PCINT16)
15	PH3 (OC4A)	40	PL5 (OC5C)	65	PJ2 (XCK3/PCINT11)	90	PF7 (ADC7/TDI)
16	PH4 (OC4B)	41	PL6	66	PJ3 (PCINT12)	91	PF6 (ADC6/TDO)
17	PH5 (OC4C)	42	PL7	67	PJ4 (PCINT13)	92	PF5 (ADC5/TMS)
18	PH6 (OC2B)	43	PD0 (SCL/INT0)	68	PJ5 (PCINT14)	93	PF4 (ADC4/TCK)
19	PB0 (SS/PCINT0)	44	PD1 (SDA/INT1)	69	PJ6 (PCINT15)	94	PF3 (ADC3)
20	PB1 (SCK/PCINT1)	45	PD2 (RXD1/INT2)	70	PG2 (ALE)	95	PF2 (ADC2)
21	PB2 (MOSI/PCINT2)	46	PD3 (TXD1/INT3)	71	PA7 (AD7)	96	PF1 (ADC1)
22	PB3 (MISO/PCINT3)	47	PD4 (ICP1)	72	PA6 (AD6)	97	PF0 (ADC0)
23	PB4 (OC2A/PCINT4)	48	PD5 (XCK1)	73	PA5 (AD5)	98	AREF
24	PB5 (OC1A/PCINT5)	49	PD6 (T1)	74	PA4 (AD4)	99	GND
25	PB6 (OC1B/PCINT6)	50	PD7 (T0)	75	PA3 (AD3)	100	AVCC

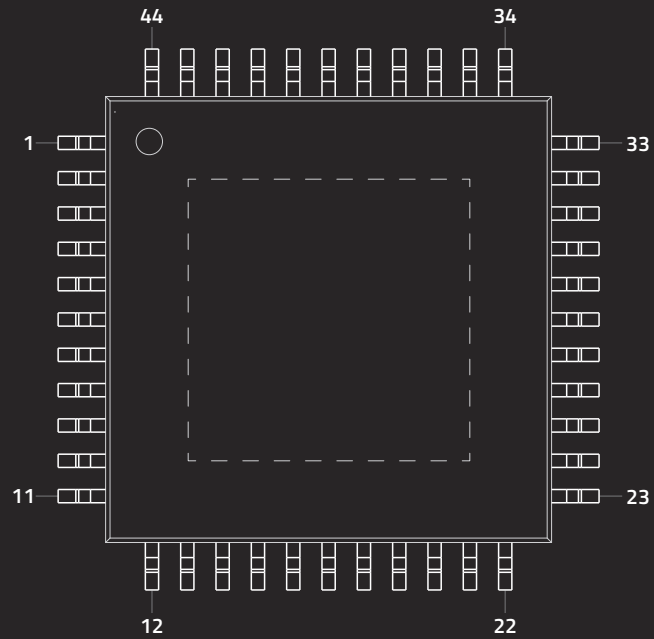

#	NAME	NOTES	#	NAME	NOTES
1	PB5 (MOSI)	PORT B. AN 8-BIT I/O PORT WITH INTERNAL PULL-UP RESISTORS	23	PC4 (TDO)	PORT C. 8-BIT I/O PORT WITH INTERNAL PULL-UP RESISTORS. ALSO SERVES JTAG INTERFACE FUNCTIONS
2	PB6 (MISO)		24	PC5 (TDI)	
3	PB7 (SCK)		25	PC6 (TOSC1)	
4	RESET	RESET INPUT	26	PC7 (TOSC2)	
5	VCC	SUPPLY VOLTAGE (4.5V-5.5V)	27	AVCC	SUPPLY VOLTAGE FOR PORT A*
6	GND	GROUND	28	GND	GROUND
7	XTAL2	OSCILLATOR INPUT	29	AREF	ANALOG REFERENCE PIN
8	XTAL1	OSCILLATOR OUTPUT	30	PA7 (ADC7)	PORT A. SERVES AS ANALOG INPUT TO A/D CONVERTER.  ALSO 8-BIT I/O PORT
9	PD0 (RXD)	PORT D. 8-BIT I/O PORT WITH INTERNAL PULL-UP RESISTORS	31	PA6 (ADC6)	
10	PD1 (TXD)		32	PA5 (ADC5)	
11	PD2 (INT0)		33	PA4 (ADC4)	
12	PD3 (INT1)		34	PA3 (ADC3)	
13	PD4 (OC1B)		35	PA2 (ADC2)	
14	PD5 (OC1A)		36	PA1 (ADC1)	
15	PD6 (ICP1)		37	PA0 (ADC0)	
16	PD7 (OC2)		38	VCC	
17	VCC		SUPPLY VOLTAGE (4.5V-5.5V)	39	GND
18	GND	GROUND	40	PB0 (XCK/T0)	PORT B. AN 8-BIT I/O PORT WITH INTERNAL PULL-UP RESISTORS
19	PC0 (SCL)	PORT C. 8-BIT I/O PORT WITH INTERNAL PULL-UP RESISTORS. ALSO SERVES JTAG INTERFACE FUNCTIONS	41	PB1 (T1)	
20	PC1 (SDA)		42	PB2 (AIN0/INT2)	
21	PC2 (TCK)		43	PB3 (AIN1/OCO)	
22	PC3 (TMS)		44	PB4 (SS)	

\* Also supply voltage for A/D Converter. Should be externally connected to VCC even if the ADC is not used. If the ADC is used, it should be connected to VCC through a low-pass filter.

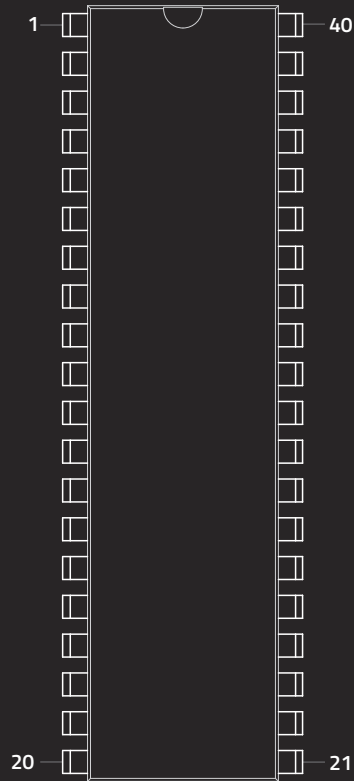

#	NAME	NOTES	#	NAME	NOTES
1	PB0 (XCK/T0)	PORT B. AN 8-BIT I/O PORT WITH INTERNAL PULL-UP RESISTORS	21	PD7 (OC2)	
2	PB1 (T1)		22	PC0 (SCL)	PORT C. 8-BIT I/O PORT WITH INTERNAL PULL-UP RESISTORS. ALSO SERVES JTAG INTERFACE FUNCTIONS
3	PB2 (INT2/AIN0)		23	PC1 (SDA)	
4	PB3 (OCO/AIN1)		24	PC2 (TCK)	
5	PB4 (SS)		25	PC3 (TMS)	
6	PB5 (MOSI)		26	PC4 (TDO)	
7	PB6 (MISO)		27	PC5 (TDI)	
8	PB7 (SCK)		28	PC6 (TOSC1)	
9	RESET	RESET INPUT	29	PC7 (TOSC2)	
10	VCC	SUPPLY VOLTAGE (4.5V-5.5V)	30	AVCC	SUPPLY VOLTAGE FOR PORT A*
11	GND	GROUND	31	GND	GROUND
12	XTAL2	OSCILLATOR OUTPUT	32	AREF	ANALOG REFERENCE PIN
13	XTAL1	OSCILLATOR INPUT	33	PA7 (ADC7)	PORT A. SERVES AS ANALOG INPUT TO A/D CONVERTER.  ALSO 8-BIT I/O PORT
14	PD0 (RXD)	PORT D. AN 8-BIT I/O PORT WITH INTERNAL PULL-UP RESISTORS  ALSO SERVES FUNCTIONS OF VARIOUS SPECIAL ATMEGA32 FEATURES	34	PA6 (ADC6)	
15	PD1 (TXD)		35	PA5 (ADC5)	
16	PD2 (INT0)		36	PA4 (ADC4)	
17	PD3 (INT1)		37	PA3 (ADC3)	
18	PD4 (OC1B)		38	PA2 (ADC2)	
19	PD5 (OC1A)		39	PA1 (ADC1)	
20	PD6 (ICP1)		40	PA0 (ADC0)	

\* Also supply voltage for A/D Converter. Should be externally connected to VCC even if the ADC is not used. If the ADC is used, it should be connected to VCC through a low-pass filter.

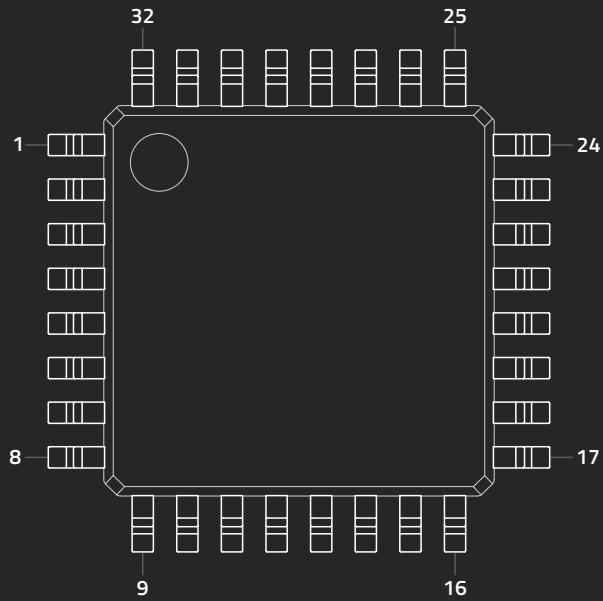

#	NAME	NOTES	#	NAME	NOTES
1	PD3 (PCINT19/OC2B/INT1)	SEE NOTE 1	17	PB5 (SCK/PCINT5)	SEE NOTE 1
2	PD4 (PCINT20/XCK/T0)	SEE NOTE 1	18	AVCC	SEE NOTE 3
3	GND	GROUND	19	ADC6	A/D CONVERTER INPUT
4	VCC	VOLTAGE SUPPLY (1.8V-5.5V)	20	AREF	ANALOG REFERENCE PIN
5	GND	GROUND	21	GND	GROUND
6	VCC	VOLTAGE SUPPLY (1.8V-5.5V)	22	ADC7	A/D CONVERTER INPUT
7	PB6 (PCINT6/XTAL1/TOSC1)	SEE NOTE 1	23	PC0 (ADC0/PCINT8)	SEE NOTE 2
8	PB7 (PCINT7/XTAL2/TOSC2)	SEE NOTE 1	24	PC1 (ADC1/PCINT9)	SEE NOTE 2
9	PD5 (PCINT21/OC0B/T1)	SEE NOTE 1	25	PC2 (ADC2/PCINT10)	SEE NOTE 2
10	PD6 (PCINT22/OC0A/AINO)	SEE NOTE 1	26	PC3 (ADC3/PCINT11)	SEE NOTE 2
11	PD7 (PCINT23/AIN1)	SEE NOTE 1	27	PC4 (ADC4/SDA/PCINT12)	SEE NOTE 2
12	PB0 (PCINT0/CLKO/ICP1)	SEE NOTE 1	28	PC5 (ADC5/SCL/PCINT13)	SEE NOTE 2
13	PB1 (PCINT1/OC1A)	SEE NOTE 1	29	PC6 (RESET/PCINT14)	SEE NOTE 2
14	PB2 (PCINT2/SS/OC1B)	SEE NOTE 1	30	PD0 (RXD/PCINT16)	SEE NOTE 1
15	PB3 (PCINT3/OC2A/MOSI)	SEE NOTE 1	31	PD1 (TXD/PCINT17)	SEE NOTE 1
16	PB4 (PCINT4/MISO)	SEE NOTE 1	32	PD2 (INT0/PCINT18)	SEE NOTE 1

NOTE 1: Ports B & D are 8-bit bi-directional I/O ports with internal pull-up resistors (selected for each bit). As inputs, Ports B & D pins that are externally pulled low will source current if the pull-up resistors are activated. Refer to the datasheet for alternate functions of Ports B & D.

NOTE 2: Port C is a 7-bit bi-directional I/O port with internal pull-up resistors (selected for each bit). As inputs, Port C pins that are externally pulled low will source current if the pull-up resistors are activated. Refer to the datasheet for alternate functions of Port C.

NOTE 3: AVCC is the supply voltage pin for the A/D Converter, PC3:0 and ADC7:6. It should be externally connected to VCC even if ADC is not used.

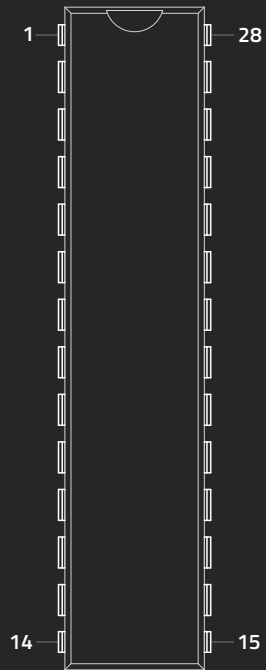



#	NAME	NOTES	#	NAME	NOTES
1	PC6 (PCINT14/RESET)	SEE NOTE 2	15	PB1 (OC1A/PCINT1)	SEE NOTE 1
2	PD0 (PCINT16/RXD)	SEE NOTE 1	16	PB2 (SS/OC1B/PCINT2)	SEE NOTE 1
3	PD1 (PCINT17/TXD)	SEE NOTE 1	17	PB3 (MOSI/OC2A/PCINT3)	SEE NOTE 1
4	PD2 (PCINT18/INT0)	SEE NOTE 1	18	PB4 (MISO/PCINT4)	SEE NOTE 1
5	PD3 (PCINT19/OC2B/INT1)	SEE NOTE 1	19	PB5 (SCK/PCINT5)	SEE NOTE 1
6	PD4 (PCINT20/XCK/T0)	SEE NOTE 1	20	AVCC	SEE NOTE 3
7	VCC	VOLTAGE SUPPLY (1.8-5.5V)	21	AREF	ANALOG REFERENCE PIN
8	GND	GROUND	22	GND	GROUND
9	PB6 (PCINT6/XTAL1/TOSC1)	SEE NOTE 1	23	PC0 (ADC0/PCINT8)	SEE NOTE 2
10	PB7 (PCINT7/XTAL2/TOSC2)	SEE NOTE 1	24	PC1 (ADC1/PCINT9)	SEE NOTE 2
11	PD5 (PCINT21/OC0B/T1)	SEE NOTE 1	25	PC2 (ADC2/PCINT10)	SEE NOTE 2
12	PD6 (PCINT22/OC0A/AIN0)	SEE NOTE 1	26	PC3 (ADC3/PCINT11)	SEE NOTE 2
13	PD7 (PCINT23/AIN1)	SEE NOTE 1	27	PC4 (ADC4/SDA/PCINT12)	SEE NOTE 2
14	PB0 (PCINT0/CLKO/ICP1)	SEE NOTE 1	28	PC5 (ADC5/SCL/PCINT13)	SEE NOTE 2

*NOTE 1: Ports B & D are 8-bit bi-directional I/O ports with internal pull-up resistors (selected for each bit). As inputs, Ports B & D pins that are externally pulled low will source current if the pull-up resistors are activated. Refer to the datasheet for alternate functions of Ports B & D.*

*NOTE 2: Port C is a 7-bit bi-directional I/O port with internal pull-up resistors (selected for each bit). As inputs, Port C pins that are externally pulled low will source current if the pull-up resistors are activated. Refer to the datasheet for alternate functions of Port C.*

*NOTE 3: AVCC is the supply voltage pin for the A/D Converter, PC3:0 and ADC7:6. It should be externally connected to VCC even if ADC is not used.*

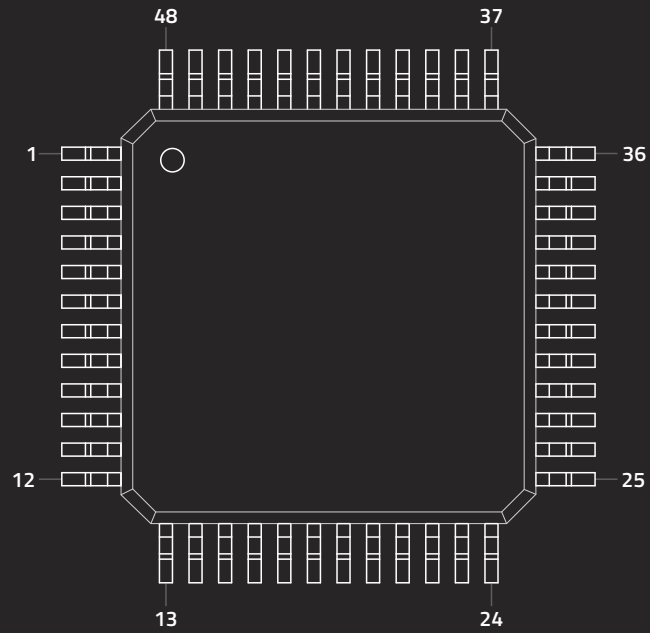

#	NAME	#	NAME	#	NAME	#	NAME
1	PA00	13	PA08	25	PA16	37	PB22
2	PA01	14	PA09	26	PA17	38	PB23
3	PA02	15	PA10	27	PA18	39	PA27
4	PA03	16	PA11	28	PA19	40	RESET
5	GNDANA	17	VDDIO	29	PA20	41	PA28
6	VDDANA	18	GND	30	PA21	42	GND
7	PB08	19	PB10	31	PA22	43	VDDCORE
8	PB09	20	PB11	32	PA23	44	VDDIN
9	PA04	21	PA12	33	PA24	45	PA30
10	PA05	22	PA13	34	PA25	46	PA31
11	PA06	23	PA14	35	GND	47	PB02
12	PA07	24	PA15	36	VDDIO	48	PB03

*Operating voltage: 1.62V - 3.63V*

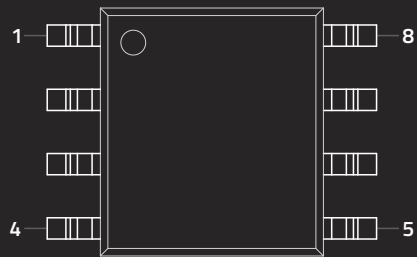

#	NAME	NOTES
1	PB5 (PCINT5/RESET/ADC0/DW)	PORT B. 6-BIT BI-DIRECTIONAL I/O PORT WITH INTERNAL PULL-UP RESISTORS. ALSO SERVES VARIOUS SPECIAL FEATURES (IN ROUND BRACKETS)*
2	PB3 (PCINT3/XTAL1/CLKI/OC1B/ADC3)	
3	PB4 (PCINT4/XTAL2/CLKO/OC1B/ADC2)	
4	GND	GROUND
5	PB0 (MOSI/DI/SDA/AINO/OC0A/OC1A/AREF/PCINT0)	PORT B. 6-BIT BI-DIRECTIONAL I/O PORT WITH INTERNAL PULL-UP RESISTORS. ALSO SERVES VARIOUS SPECIAL FEATURES (IN ROUND BRACKETS)*
6	PB1 (MISO/DO/AIN1/OC0B/OC1A/PCINT1)	
7	PB2 (SCK/USCK/SCL/ADC1/T0/INT0/PCINT2)	
8	VCC	SUPPLY VOLTAGE (2.7 - 5.5V)

*\*On the ATtiny25, ports PB3 and PB4 are exchanged in ATtiny15 Compatibility Mode for backwards compatibility with ATtiny15.*

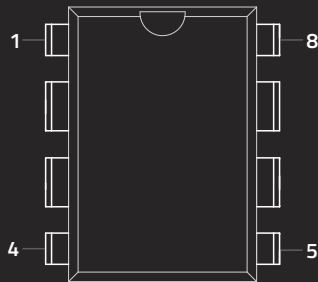

#	NAME	NOTES
1	PB5 (PCINT5/RESET/ADC0/DW)	PORT B. 6-BIT BI-DIRECTIONAL I/O PORT WITH INTERNAL PULL-UP RESISTORS. ALSO SERVES VARIOUS SPECIAL FEATURES (IN ROUND BRACKETS)*
2	PB3 (PCINT3/XTAL1/CLKI/OC1B/ADC3)	
3	PB4 (PCINT4/XTAL2/CLKO/OC1B/ADC2)	
4	GND	GROUND
5	PB0 (MOSI/DI/SDA/AINO/OC0A/OC1A/AREF/PCINT0)	PORT B. 6-BIT BI-DIRECTIONAL I/O PORT WITH INTERNAL PULL-UP RESISTORS. ALSO SERVES VARIOUS SPECIAL FEATURES (IN ROUND BRACKETS)*
6	PB1 (MISO/DO/AIN1/OC0B/OC1A/PCINT1)	
7	PB2 (SCK/USCK/SCL/ADC1/T0/INT0/PCINT2)	
8	VCC	SUPPLY VOLTAGE (2.7 - 5.5V)

*\*On the Attiny25, ports PB3 and PB4 are exchanged in Attiny15 Compatibility Mode for backwards compatibility with Attiny15.*

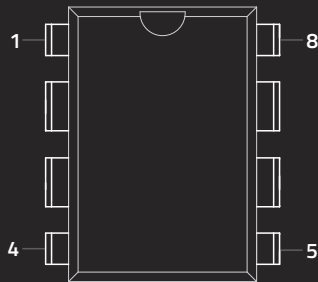



#	NAME	NOTES
1	PB5 (PCINT5/RESET/ADCO/DW)	PORT B. 6-BIT BI-DIRECTIONAL I/O PORT WITH INTERNAL PULL-UP RESISTORS. ALSO SERVES VARIOUS SPECIAL FEATURES (IN ROUND BRACKETS)
2	PB3 (PCINT3/XTAL1/CLKI/OC1B/ADC3)	
3	PB4 (PCINT4/XTAL2/CLKO/OC1B/ADC2)	
4	GND	GROUND
5	PB0 (MOSI/DI/SDA/AINO/OC0A/OC1A/AREF/PCINT0)	PORT B. 6-BIT BI-DIRECTIONAL I/O PORT WITH INTERNAL PULL-UP RESISTORS. ALSO SERVES VARIOUS SPECIAL FEATURES (IN ROUND BRACKETS)
6	PB1 (MISO/DO/AIN1/OC0B/OC1A/PCINT1)	
7	PB2 (SCK/USCK/SCL/ADC1/T0/INT0/PCINT2)	
8	VCC	SUPPLY VOLTAGE (2.7 - 5.5V)

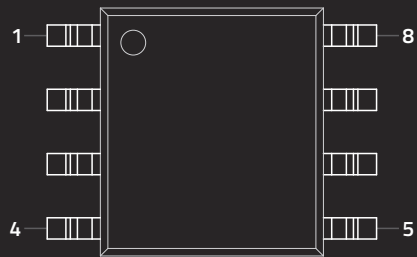

#	NAME	NOTES
1	PB5 (PCINT5/RESET/ADCO/DW)	PORT B. 6-BIT BI-DIRECTIONAL I/O PORT WITH INTERNAL PULL-UP RESISTORS. ALSO SERVES VARIOUS SPECIAL FEATURES (IN ROUND BRACKETS)
2	PB3 (PCINT3/XTAL1/CLKI/OC1B/ADC3)	
3	PB4 (PCINT4/XTAL2/CLKO/OC1B/ADC2)	
4	GND	GROUND
5	PB0 (MOSI/DI/SDA/AINO/OC0A/OC1A/AREF/PCINT0)	PORT B. 6-BIT BI-DIRECTIONAL I/O PORT WITH INTERNAL PULL-UP RESISTORS. ALSO SERVES VARIOUS SPECIAL FEATURES (IN ROUND BRACKETS)
6	PB1 (MISO/DO/AIN1/OC0B/OC1A/PCINT1)	
7	PB2 (SCK/USCK/SCL/ADC1/T0/INT0/PCINT2)	
8	VCC	SUPPLY VOLTAGE (2.7 - 5.5V)

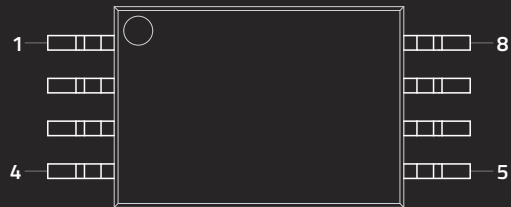

#	NAME	NOTES
1	PB5 (PCINT5/RESET/ADCO/DW)	PORT B. 6-BIT BI-DIRECTIONAL I/O PORT WITH INTERNAL PULL-UP RESISTORS. ALSO SERVES VARIOUS SPECIAL FEATURES (IN ROUND BRACKETS)
2	PB3 (PCINT3/XTAL1/CLKI/OC1B/ADC3)	
3	PB4 (PCINT4/XTAL2/CLKO/OC1B/ADC2)	
4	GND	GROUND
5	PB0 (MOSI/DI/SDA/AINO/OC0A/OC1A/AREF/PCINT0)	PORT B. 6-BIT BI-DIRECTIONAL I/O PORT WITH INTERNAL PULL-UP RESISTORS. ALSO SERVES VARIOUS SPECIAL FEATURES (IN ROUND BRACKETS)
6	PB1 (MISO/DO/AIN1/OC0B/OC1A/PCINT1)	
7	PB2 (SCK/USCK/SCL/ADC1/T0/INT0/PCINT2)	
8	VCC	SUPPLY VOLTAGE (2.7 - 5.5V)

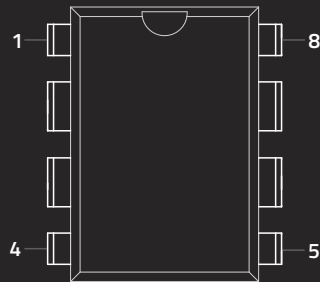

#	NAME	NOTES
1	PB5 (PCINT5/RESET/ADCO/DW)	PORT B. 6-BIT BI-DIRECTIONAL I/O PORT WITH INTERNAL PULL-UP RESISTORS. ALSO SERVES VARIOUS SPECIAL FEATURES (IN ROUND BRACKETS)
2	PB3 (PCINT3/XTAL1/CLKI/OC1B/ADC3)	
3	PB4 (PCINT4/XTAL2/CLKO/OC1B/ADC2)	
4	GND	GROUND
5	PB0 (MOSI/DI/SDA/AINO/OC0A/OC1A/AREF/PCINT0)	PORT B. 6-BIT BI-DIRECTIONAL I/O PORT WITH INTERNAL PULL-UP RESISTORS. ALSO SERVES VARIOUS SPECIAL FEATURES (IN ROUND BRACKETS)
6	PB1 (MISO/DO/AIN1/OC0B/OC1A/PCINT1)	
7	PB2 (SCK/USCK/SCL/ADC1/T0/INT0/PCINT2)	
8	VCC	SUPPLY VOLTAGE (2.7 - 5.5V)

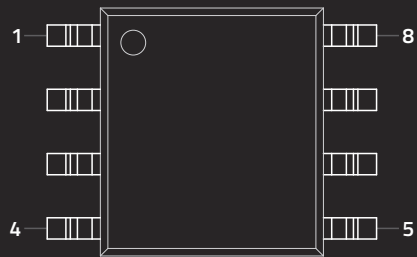



#	NAME	NOTES
1	PB5 (PCINT5/RESET/ADCO/DW)	PORT B. 6-BIT BI-DIRECTIONAL I/O PORT WITH INTERNAL PULL-UP RESISTORS. ALSO SERVES VARIOUS SPECIAL FEATURES (IN ROUND BRACKETS)
2	PB3 (PCINT3/XTAL1/CLKI/OC1B/ADC3)	
3	PB4 (PCINT4/XTAL2/CLKO/OC1B/ADC2)	
4	GND	GROUND
5	PB0 (MOSI/DI/SDA/AINO/OC0A/OC1A/AREF/PCINT0)	PORT B. 6-BIT BI-DIRECTIONAL I/O PORT WITH INTERNAL PULL-UP RESISTORS. ALSO SERVES VARIOUS SPECIAL FEATURES (IN ROUND BRACKETS)
6	PB1 (MISO/DO/AIN1/OC0B/OC1A/PCINT1)	
7	PB2 (SCK/USCK/SCL/ADC1/T0/INT0/PCINT2)	
8	VCC	SUPPLY VOLTAGE (2.7 - 5.5V)

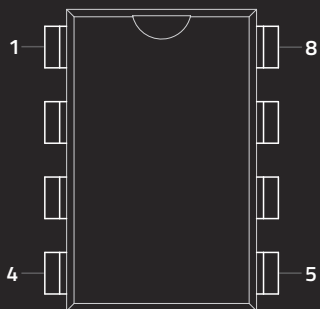

#	NAME	NOTES	TYPE
1	+V	SUPPLY VOLTAGE (4.5V OR 5V)	-
2	C.5	SERIAL IN	IN
3	C.4	TOUCH / ADC	IN / OUT
4	C.3	-	IN
5	C.2	ADC / TOUCH / PWM / TUNE / SRQ / HI2C SDA	IN / OUT
6	C.1	ADC / TOUCH / HSERIN / SRI / HI2C SCL	IN / OUT
7	C.0	HSEROUT / DAC	OUT
8	0V	-	-

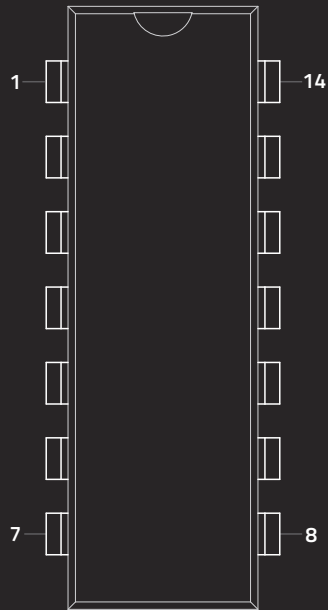

#	NAME	NOTES	TYPE
1	+V	SUPPLY VOLTAGE (4.5V OR 5V)	-
2	C.5	SERIAL IN	IN
3	C.4	TOUCH / ADC	IN / OUT
4	C.3	-	IN
5	C.2	PWN / HPWN A / KB CLK	IN / OUT
6	C.1	HPWN B / KB DATA	IN / OUT
7	C.0	ADC / TOUCH / PWN / HPWN C	IN / OUT
8	B.5	ADC / TOUCH / HPWN D	IN / OUT
9	B.4	ADC / TOUCH / PWN / HI2C SDA	IN / OUT
10	B.3	ADC / TOUCH / HI2C SCL	IN / OUT
11	B.2	ADC / TOUCH / PWN / SRQ	IN / OUT
12	B.1	ADC / TOUCH / SRI / HSERIN	IN / OUT
13	B.0	SERIAL OUT / HSEROUT / DAC	OUT
14	0V	-	-

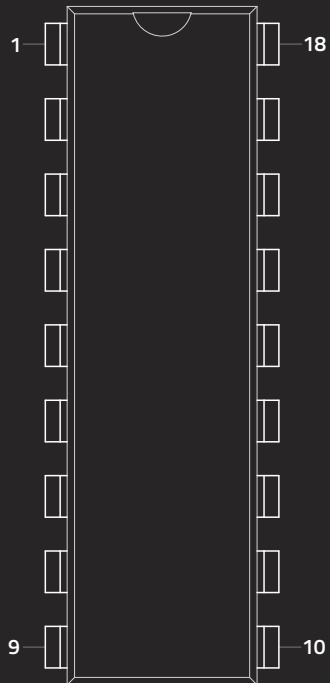

#	NAME	NOTES	TYPE
1	C.2	ADC / TOUCH / DAC	IN / OUT
2	C.3	SERIAL OUT	OUT
3	C.4	SERIAL IN	IN
4	C.5	-	IN
5	0V	-	-
6	B.0	SRI	IN / OUT
7	B.1	ADC / TOUCH / I2C SDA	IN / OUT
8	B.2	ADC / TOUCH / HSERIN	IN / OUT
9	B.3	ADC / TOUCH / PWN	IN / OUT
10	B.4	ADC / TOUCH / I2C SCL	IN / OUT
11	B.5	ADC / TOUCH / PWN / HSEROUT	IN / OUT
12	B.6	ADC / TOUCH / PWN	IN / OUT
13	B.7	ADC / TOUCH	IN / OUT
14	+V	SUPPLY VOLTAGE (4.5V OR 5V)	-
15	C.6	{KB CLOCK}	IN / OUT
16	C.7	{KB DATA}	IN / OUT
17	C.0	ADC / TOUCH	IN / OUT
18	C.1	ADC / TOUCH	IN / OUT







